



## The Alien Pro Lite Digital Video Recorder Operations Manual

### Models

ALIEN404 ALIEN408 ALIEN416



#### **SPECIAL FEATURE**

1fps background recording switching to 25fps on motion detect

**PLUS** 4/8/16 Channel Real Time Recording - 25fps in CIF  
4/8/16 Channel Simultaneous Playback

VERSION 5.

## **Preventive and Cautionary Tips**

Before connecting and operating your DVR, please be advised of the following tips:

- Ensure unit is installed in a well-ventilated, dust-free environment.
- Unit is designed for indoor use only.
- Keep all liquids away from the DVR.
- Ensure environmental conditions meet factory specifications.
- Ensure unit is properly secured to a rack or shelf. Major shocks or jolts to the unit as a result of dropping it may cause damage to the sensitive electronics within the unit.
- Use the DVR in conjunction with an UPS if possible.
- Power down the unit before connecting and disconnecting accessories and peripherals.

<b>Contents</b>	<b>Page</b>
Preventive and Cautionary Tips	2
Contents List	3
<b>1. Introduction</b>	<b>5</b>
1.1 Overview	5
1.2 Product Key Features	5
1.3 Production Application Diagram	7
1.4 Operating Your DVR	7
<b>2. Getting Started</b>	<b>15</b>
2.1 Starting and Shutting Down Your DVR	15
2.2 Rebooting and Locking Your DVR	15
2.3 Using the Setup Wizard	16
2.4 Setting Date & Time	18
<b>3. Live Preview</b>	<b>20</b>
3.1 Watching a Live Preview	20
3.2 Understanding Live Preview Icons	20
3.3 Operating the Live Preview	20
3.4 Using the Mouse in Live Preview	21
3.5 Using Digital Zoom	21
3.6 Configuring Live Preview Displays	22
3.7 Setting Camera Order	22
<b>4. Record Settings</b>	<b>23</b>
4.1 Configuring Settings for Recording	23
4.2 Initialising Record Settings	23
4.3 Scheduling a Recording	25
4.4 Starting a Manual Recording	25
4.5 Protecting Recorded Files	26
4.6 Configuring Advanced HDD Settings	28
<b>5. Playback</b>	<b>30</b>
5.1 Playing Back a Recording	30
5.2 Understanding the Playback Interface	30
5.3 Playing Back from Search	31
5.4 Playing Back from Live Preview	31
5.5 Playing Back from System Log	30
5.6 Playing Back Frame-by-Frame	33
5.7 Using Digital Zoom	33
<b>6. Backup</b>	<b>34</b>
6.1 Backing up Recorded Files	34
6.2 Exporting Files	34
6.3 Exporting Video Clips	36
6.4 Managing Backup Devices	37
<b>7. Alarm Settings</b>	<b>38</b>
7.1 Configuring Alarms	38
7.2 Detecting Video Loss	42
7.3 Detecting Video Tampering	43
7.4 Setting Exceptions	44
7.5 Understanding Exception Trigger Options	45

<b>8. Network Settings</b>	<b>46</b>
8.1 Configuring Network Settings	46
8.2 Configuring Basic Settings	46
8.3 Configuring PPPoE Settings	47
8.4 Configuring DDNS	47
8.5 Configuring an NTP Server	48
8.6 Configuring a Remote Alarm Host	48
8.7 Configuring Multicast	49
8.8 Configuring Server and HTTP Ports	50
<b>9. PTZ Controls</b>	<b>51</b>
9.1 Navigating PTZ Menus	51
9.2 Configuring PTZ Settings	51
9.3 Setting PTZ Presets, Patrols & Patterns	52
<b>10. Camera Management</b>	<b>56</b>
10.1 Configuring OSD Settings	56
10.2 Setting up Privacy Mask	56
10.3 Adjusting Display Settings	57
<b>11. HDD Management</b>	<b>58</b>
11.1 Initialising HDDs	58
11.2 Setting HDD Groups	58
11.3 Setting HDD Status	59
11.4 Checking HDD Status	60
11.5 Configuring HDD Alarms	61
<b>12. DVR Management</b>	<b>62</b>
12.1 Configuring General Settings	62
12.2 Configuring Advanced Settings	62
12.3 Configuring RS-232 Port Settings	63
12.4 Managing User Accounts	64
12.5 Importing & Exporting Configuration	67
12.6 Updating System Firmware	68
12.7 Restoring Default Settings	69
12.8 Viewing System Information	69
12.9 Viewing System Logs	70
<b>13. Glossary</b>	<b>72</b>
<b>14. Frequently Asked Questions</b>	<b>73</b>
<b>15. Record Timings</b>	<b>74</b>
15.1 Record Timings for Alien416	74
15.2 Record Timings for Alien408	75
15.3 Record Timings for Alien404	76
<b>16. Special Features</b>	<b>77</b>
16.1 1fps background recording switching to 25fps in CIF	77
16.2 Special Instructions following Restoring Default Settings	79

# 1. Introduction

## 1.1 Overview

Thank you for your purchase of the ALIEN Digital Video Recorder. To get the most out of your DVR, please read through the Operations Manual thoroughly.

This product is a new generation product built on an embedded platform and combining the latest in advanced H.264 video encoding and decoding technologies maintaining solid reliability and high performance.



## 1.2 Product Key Features

### Compression

- Support PAL/NTSC video input.
- Adopt H.264 video compression standard.
- Video encoding parameters of each channel can be set separately, including resolution, frame rate, bit rate, image quality.
- Each channel supports normal continuous and event compression parameters.
- Supports both composite stream and video only stream. Audio and video are strictly simultaneous.

### Monitoring:

- High definition VGA display supports 1024 x 768 resolution.
- Supports 1/4/9/16 screen live view, channel sequence is adjustable.
- Supports live view group switch, manual switch and automatic sequencing (the interval of automatic sequencing can be adjusted.)
- Supports digital zoom on live view.
- Supports shielding the assigned live view channel.
- Supports motion detection, view tampering alert, video exception alert and video loss alert.
- Supports privacy masking.
- Supports various PTZ protocols, PTZ preset, patrols and patterns.
- Supports zoom by clicking the mouse and trace function by dragging the mouse.

### HDD Management:

- Supports 4 SATA HDD's. Each HDD can support up to 2TB capacity.
- Supports S.M.A.R.T. technology.
- Supports HDD standby function.
- Supports hard disk group management.
- Uses pre-allocating hard disk management technology and creates no disk fragmentation.

### Recording and Playback

- Supports overwrite and non-overwrite recording modes.
- Supports normal and event video encoding parameters.

- Supports manual, continuous, alarm, motion, motion|alarm and motion & alarm recording.
- Supports 8 recording time periods with separate recording types.
- Supports Pre-record and Post-record time for alarm and motion detection.
- Supports lock and unlock video files.
- Supports local redundant recording.
- Supports setting hard disk to read only.
- Supports video data search and playback by channel number, recording type & time.
- Supports digital zoom function in playback.
- Supports pause, play fast, play slow, skip forward, and skip backward when in playback with option to adjust progress bar by dragging the mouse.

### **Backup**

- Supports USB device backup.
- Supports SATA CD/DVD-R/W backup.
- Supports backup by file or by time.
- Supports backup device maintenance and management.
- Supports video clip backup when in playback.

### **Alarm & Exceptions**

- Supports alarm in/out arming schedule setting.
- Supports various alarm conditions such as hard disk full, illegal access, network failure, IP conflicts, hard disk error, video loss and video output standard mismatch.
- Supports various alarm responses such as camera recording, relay out, on screen warning, audible warning and upload to center.
- Supports auto recovery from exceptions.

### **Network**

- Supports 10/100M adaptive network interface.
- Supports TCP/IP protocols, PPPoE, DHCP, DNS, DDNS, NTP, and SADP.
- Supports remote search, playback, download video files and breakpoint resume.
- Supports remote configuration, supports remote import and export of DVR settings.
- Supports remote acquisition of device status, system log and alarm status.
- Supports remote button operation, remote locking and unlocking of panel buttons.
- Supports remote hard disk formatting, upgrade, reboot and shutdown.
- Supports RS-232 and RS-485 transparent channel transmission.
- Supports event alarm and exceptions upload to remote management host.
- Supports remote manual recording.
- Supports remote PTZ control.
- Supports voice talk and broadcast.
- Supports a maximum of 18 TCP/IP connections overall.
- Supports a maximum of 6 TCP/IP connections to any individual camera stream.
- Supports substream viewing in QCIF at 8 frames per second.
- Built-in WEB Server.

## 1.3 Product Application Diagram

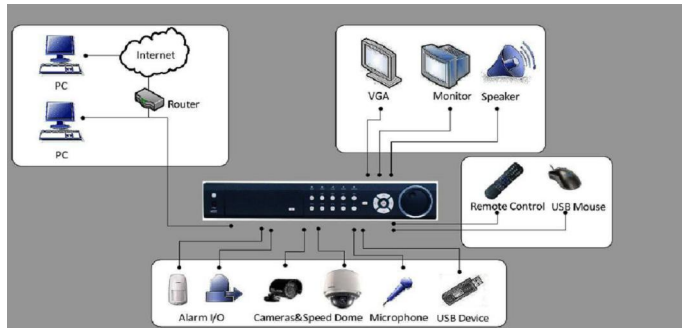

## 1.4 Operating Your DVR

There are numerous ways to navigate and operate your DVR. You may use the **Front Panel Controls**, the included **IR (Infra-Red) Remote**, a **Mouse** and the **Soft Keyboard**.

### 1.4.1 Using the Front Panel Controls

Your DVR comes with built-in front panel controls, as shown below.



The controls on the front panel include:

**1. USB Port:** Universal Serial Bus (USB) port for additional devices such as USB mouse and USB Hard Disk Drive (HDD).

**2. Status Indicators:** Status indicators for different features of the DVR.

- **Alarm:** Alarm indicator turns red when a sensor alarm is detected.
- **Ready:** Ready indicator turns green when DVR is functioning properly.
- **Status:** Status indicator turns green when DVR is controlled by an IR remote.
- **HDD:** HDD indicator blinks red when data is being read from or written to HDD.
- **NETWORK:** NETWORK indicator blinks blue when network connection is functioning properly.

**3. Control Buttons:**

- **1/MENU Button:** The 1/MENU button works as numeric [1]. Pressing this button will return the user to the Main menu (after successful login). The 1/MENU button will also bring up Sensitivity Interface settings.
- **2ABC/F1:** The 2ABC button works as numeric [2] and letter [ABC]. When it is used in a list field will select all items on the list.

- **3DEF/F2:** The 3DEF button works as numeric [3] and letter [DEF]. It is also used to cycle through tab pages.
- **4GHI/ESC:** The 4GHI/ESC button works as numeric [4] and letter [GHI] is also used to escape to the previous menu
- **5JKL/EDIT:** The 5JKL/EDIT button works as numeric [5] and letter [JKL]. The 5JKL/EDIT button is used to edit text fields. When editing text fields, it will also function as a Backspace button to delete the character in front of the cursor. On checkbox fields, pressing the EDIT/IRIS+ button will *tick* the checkbox. In Playback mode, it can be used to generate video clips for backup.
- **6MNO/PLAY:** The 6MNO/PLAY button works as numeric [6] and letter [MNO]. It is used to enter the Playback menu. It is also used to turn audio on/off in the Playback menu.
- **7PQRS/REC:** The 7PQRS/REC button works as numeric [7] and letter [PQRS]. It is also used to enter the Manual Record interface.
- **8TUV/PTZ:** The 8TUV/PTZ button works as numeric [8] and letter [TUV]. It is also used to enter the PTZ Control mode.
- **9WXYZ/PREVIEW:** The 9WXYZ/PREVIEW button works as numeric [9] and letter [WXYZ]. It is also used to switch between single screen and multi-screen mode.
- **0/A:** The 0/A button works as numeric [0]. It is also used to switch between input methods (upper and lowercase alphabet, symbols and numeric input). It can also be used to clear entire masked areas, such as in the Motion Detection and Privacy Mask menus.
- **SHIFT:** The SHIFT button is used for switch button action between numeric button and control button.

#### 4. Direction/Enter Buttons

- **DIRECTION Buttons:** The DIRECTION buttons are used to navigate between different fields and items in menus. In Playback mode, the Up and Down button is used to speed up and slow down recorded video. The Left and Right button will jump 30s backward and forward in a video. In Preview mode, these buttons can be used to cycle through channels.
- **ENTER Button:** The ENTER button is used to confirm selection in any of the menu modes. It can also be used to *tick* checkbox fields. In Playback mode, it can be used to play or pause the video. In Single Play mode, pressing the ENTER button will advance the video by a single frame.

**5. JOG SHUTTLE Control:** The JOG SHUTTLE control can be used to move the active selection in a menu. The inner ring will move the selection up and down; the outer ring will move it left and right. In the Playback mode, the outer ring is used to jump 30s forward/backward in video files. The inner ring can be used to speed up/slow down the video. In Preview mode, it can be used to cycle through different channels.

**6. POWER Button:** The POWER button is used for power on or power off the DVR.

**Note:** It is important to note that you must click the EDIT button on either the remote or front panel on a text field before you are able to edit its content. After entering text, you must hit the ENTER button to be able to move on to the next field.



### 1.4.2 Using the IR Remote Control

Your DVR may also be controlled with the included IR remote control. Batteries (2x AAA) must be installed before operating.

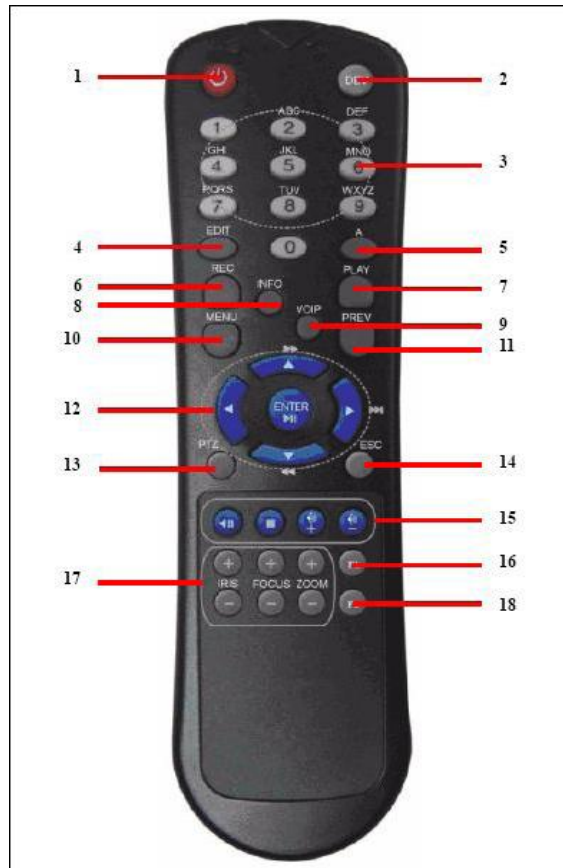

The keys on the remote control closely resemble the ones found on the front panel. They include:

- 1. POWER Button:** Power off DVR.
- 2. DEV Button:** Enables/Disables Remote Control.
- 3. Alphanumeric Buttons:** Same as Alphanumeric buttons on front panel.
- 4. EDIT Button:** Same as EDIT button on front panel.
- 5. A Button:** Same as A button on front panel.
- 6. REC Button:** Same as REC button on front panel.
- 7. PLAY Button:** Same as PLAY button on front panel.
- 8. INFO Button:** Reserved.
- 9. VOIP Button:** Reserved.
- 10. MENU Button:** Same as MENU/WIPER button on front panel.
- 11. PREV Button:** Same as PREV/FOCUS- button on front panel.
- 12. DIRECTION/ENTER Buttons:** Same as buttons on front panel.
- 13. PTZ Button:** Same as PTZ/IRIS- button on front panel.

**14. ESC Button:** Same as ESC button on front panel.

**15. RESERVED:** Reserved.

**16. F1 Button:** When it is used in a list field, it will select all items in the list.

**17. PTZ CONTROL Buttons:** Buttons to adjust the iris, focus and zoom of a PTZ camera.

**18. F2 Button:** It is also used to cycle through tab pages. Aim the remote control at the IR receiver located at the front of the unit to test operation. If there is no response:

1. Using the front control panel or the mouse, go into Menu > Settings > General > More Settings.
2. Check and remember DVR ID number. The default ID number is 255. This ID number is valid for all IR controls.
3. Press the DEV button on the remote.
4. Enter the DVR ID number in step 2.
5. Press the ENTER button on the remote.

If the Status indicator on the front panel turns blue, the remote control is operating properly. If the Status indicator does not turn blue and there is still no response from the remote, please check the following:

1. Batteries are installed correctly and the polarities of the batteries are not reversed.
2. Batteries are fresh and not flat.
3. IR receiver on DVR is not obstructed.

### 1.4.3 Using a USB Mouse

A regular 3-button (Left/Right/Scroll-wheel) USB mouse can also be used with this DVR. To use a USB mouse:

1. Plug USB mouse into one of the USB ports on the DVR.
2. The mouse should automatically be detected. If in a rare case that a mouse is not detected, please try a replacement standard USB mouse.

The buttons on the mouse correspond to:

#### **1. Left Button**

- **Single-Click:** Select a component of a menu, such as a button or an input field. This is similar to pressing the ENTER button on the remote/front panel controls.
- **Double-Click:** Switch between single screen and multi-screen mode in Preview mode.
- **Click and Drag:** Clicking and dragging the Left mouse button can be used to control the pan/tilt of a PTZ camera as well as to vary the position of digital zoom area and camera OSD. It can also be used to setup the alarm areas.

#### **2. Right Button**

- **Single-Click:** Shows pop-up menu.

#### **3. Scroll-Wheel**

- **Scroll Up:** In Preview mode, scrolling up will switch to the previous screen. In Menu mode, it will move the selection to the previous item.
- **Scroll Down:** In Preview mode, scrolling down will switch to the next screen. In Menu mode, it will move the selection to the next item.

#### 1.4.4 Using the Soft Keyboard

When a mouse is used to perform task on the DVR, clicking on a text input field will bring up the Soft Keyboard.



The buttons on the soft keyboard represents:

**Lowercase:** Designates lowercase input is being used.

**Uppercase:** Designates uppercase input is being used.

**Switch to Lowercase:** Switch to lowercase input.

**Switch to Uppercase:** Switch to uppercase input.

**Number:** Designates number input is being used.

**Symbols:** Switch to symbols input.

**Backspace:** Delete the character in front of the cursor.

**Enter:** Confirm selection.

**ESC:** Exit out of Soft Keyboard.



### 1.4.5 Rear Panel Diagram of Alien416

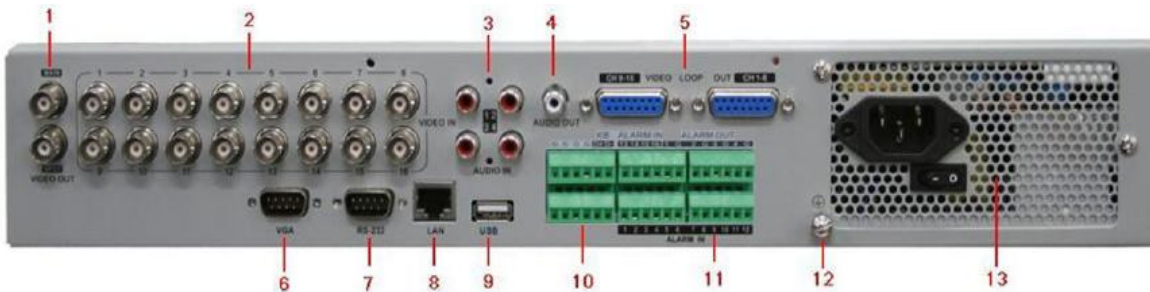

No.	Item	Description
1.	Video Out	BNC connection for video output. If VGA is connected, the interface will not function. If VGA is not connected, the interface is used as the main video output with local video display and menu operations.
	Video Spot Out	BNC connection for spot monitor. Single window view.
2.	Video In	BNC connections for analogue video input x 16
3.	Audio In	RCA connection for analogue audio input x 4
4.	Audio Out	RCA connector for audio output x 1. The connection is synchronised with Video Out.
5.	Video Loop Out	16 channel DB15 connector for video loop out.
6.	VGA	VGA output. Display local video output and menu.
7.	RS232	DB9 connector for RS232
8.	LAN Interface	Connection for LAN (Local Area Connection)
9.	USB Interface	Connection for USB devices.
10.	RS485	Connection for RS484 devices. T+, T- pins connect to PTZ. Connection for Keyboard devices . D+, D- pins connect to special keyboard.
	Alarm In	Connections for alarm inputs x 16
11.	Alarm Out	Connections for alarm outputs x 4
	Ground	Ground (needs to be connected when DVR starts up.
12.	Power	AC 100 ~ 240v

## 1.4.6 Rear Panel Diagram of Alien408

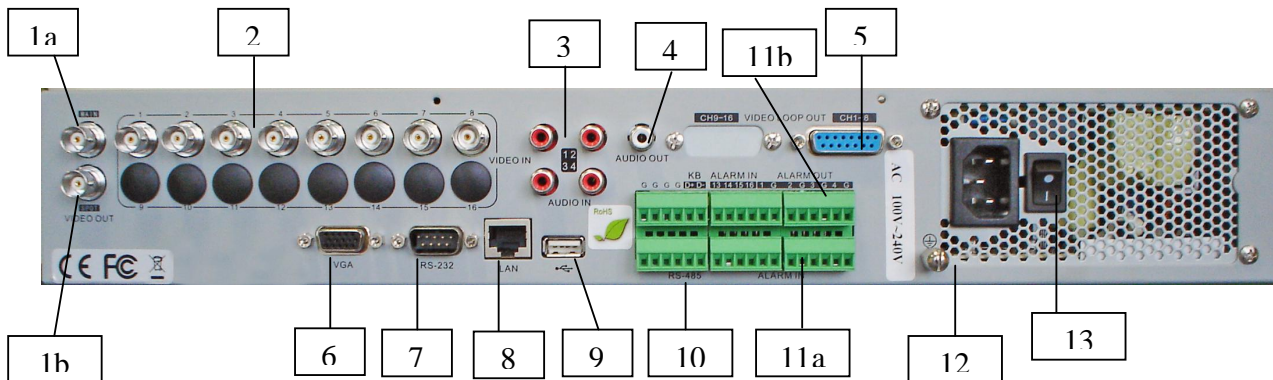

No.	Item	Description
1.	1a Video Out - Main	BNC connection for video output. If VGA is connected, the interface will not function. If VGA is not connected, the interface is used as the main video output with local video display and menu operations.
	1b Video Out - Spot	BNC connection for spot monitor. Single window view.
2.	Video In	8 x BNC connections for analogue video input.
3.	Audio In	4 x RCA connections for analogue audio input.
4.	Audio Out	RCA connector for audio output. The connection is synchronised with Video Out.
5.	Video Loop Out	DB15 connector for 8 x video loop out.
6.	VGA	VGA output. Display local video output and menu.
7.	RS232	DB9 connector for RS232
8.	LAN Interface	Connection for LAN (Local Area Connection)
9.	USB Interface	Connection for USB devices.
10.	RS485	Connection for RS484 devices. T+, T- pins connect to PTZ. Connection for Keyboard devices. D+, D- pins connect to special keyboard.
11.	11a Alarm In	8 x Connections for alarm input
	11b Alarm Out	4 x Connections for alarm output
12.	Ground	Ground (needs to be connected when DVR starts up).
13.	Power	AC 100 ~ 240v

### 1.4.7 Rear Panel Diagram of Alien404

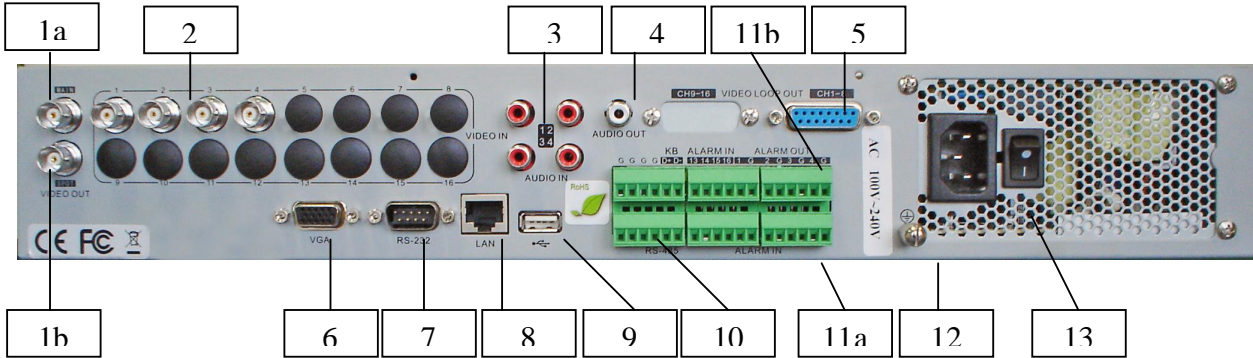

No.	Item	Description
1.	1a - Main Video Out	BNC connection for video output. If VGA is connected, the interface will not function. If VGA is not connected, the interface is used as the main video output with local video display and menu operations.
	1b - Spot Video Out	BNC connection for spot monitor. Single window view.
2.	Video In	4 x BNC connections for analogue video input.
3.	Audio In	4 x RCA connections for analogue audio input.
4.	Audio Out	1 x RCA connector for audio output. The connection is synchronised with Video Out.
5.	Video Loop Out	DB15 connector for 4 channel video loop out.
6.	VGA	VGA output. Display local video output and menu.
7.	RS232	DB9 connector for RS232
8.	LAN Interface	Connection for LAN (Local Area Connection)
9.	USB Interface	Connection for USB devices.
10.	RS485	Connection for RS484 devices. T+, T- pins connect to PTZ. Connection for Keyboard devices . D+, D- pins connect to special keyboard.
11.	11a Alarm In	4 x Connections for alarm input
	11b Alarm Out	4 x Connections for alarm outputs
12.	Ground	Ground (needs to be connected when DVR starts up.
13.	Power	AC 100 ~ 240v

## 2. Getting Started

### 2.1 Starting and Shutting Down Your DVR

Proper startup and shutdown procedures are crucial for extending the life of your DVR.

To startup your DVR:

1. Ensure the power supply is plugged into an electrical outlet. It is **HIGHLY** recommended that an Uninterruptible Power Supply (UPS) be used in conjunction with the unit.
2. Turn on the switch on rear panel
3. After startup, the Status indicator LED will remain green.

There are two proper ways to shutdown the DVR:

#### OPTION 1: Shutdown in Menu

1. Enter the Shutdown menu, shown below by clicking on Menu > Shutdown.

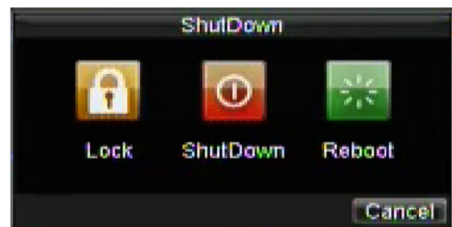

2. Select the Shutdown button.
3. Turn off switch on rear panel.

#### OPTION 2: Manual Shutdown

1. Press and hold the POWER button for 3 seconds.
2. Enter the administrator's username and password in the authentication dialogue box.
3. Click the Yes button.
4. Message "Are you sure to turn off DVR?" will be displayed.
5. Click "Yes" then message "Shutting down" will display.
6. Turn off switch on rear panel.

### 2.2 Rebooting and Locking Your DVR

While in the Shutdown menu shown above, you may also reboot or lock your DVR. Locking your DVR will return you to the Live Preview mode, which will require a user name and password to exit out of it. The Reboot button will reboot your DVR.

To reboot or lock your DVR:

1. Enter the Shutdown menu by clicking Menu > Shutdown.
2. Select the Lock button to lock the DVR or the Reboot button to reboot the DVR.

## 2.3 Using the Setup Wizard

By default, the Setup Wizard will start once the DVR has loaded, as shown below. The Setup Wizard will walk you through some of the more important settings of your DVR. If you do not wish to use the Setup Wizard at this time, click the Cancel button. You may also choose to use the Setup Wizard at a later time by leaving the “**Start Wizard when DVR starts?**” checkbox checked.



To start using the Setup Wizard:

1. Click the Next button on the Wizard window.

This will take you to the **User Permission** window, shown below.



2. Navigate to the **Admin Password** input field.

3. Enter the admin password into the **Admin Password** input field. By default, the password is 12345.

4. To change the admin password, check the **New Admin Password** checkbox. Enter the new password and confirm the password in the given fields.



5. Click the Next button. This will take you to the **HDD Management** window shown.

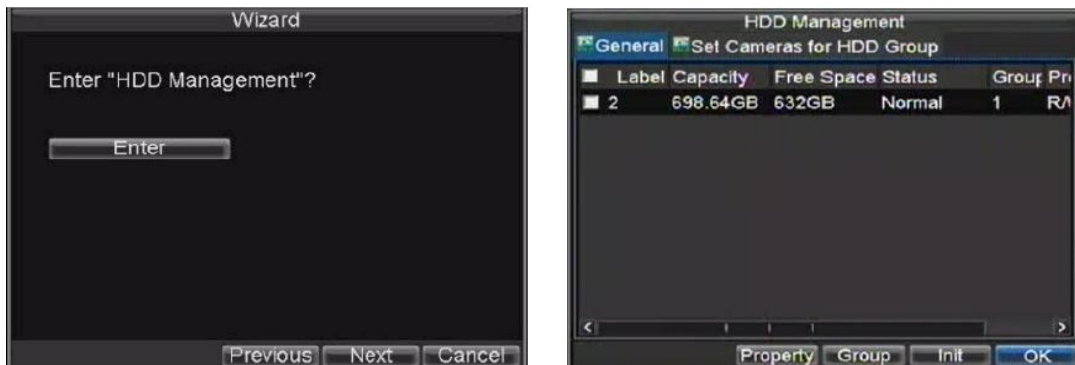

6. To start HDD management, click the Enter button.

7. If a new HDD was recently installed, select the HDD from the list to initialise it. Initialising the HDD will format and remove all data from it.

8. After the HDD has been initialised, click the OK button which will take you back to the Setup Wizard window.

9. Click the Next button. This will take you to the **Record Settings** window, as shown below.

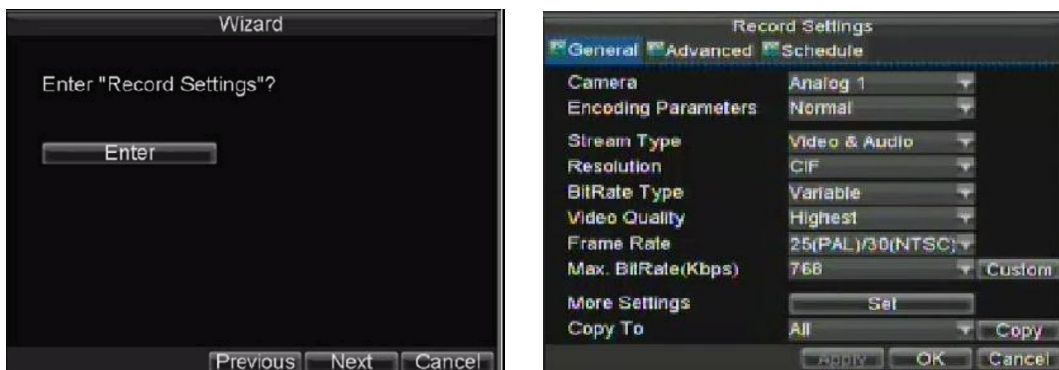

10. To enter the **Record Settings** window, click the Enter button.

11. Select the **Schedule** tab, shown in Record Settings Menu.

12. Click the Edit button. This will open up a new recording schedule, shown below.

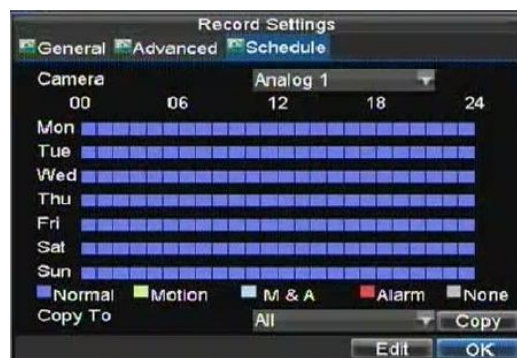

13. Check both the **Enable Schedule** and **All Day** checkbox. This will enable the recording schedule and have it record continuously all day.

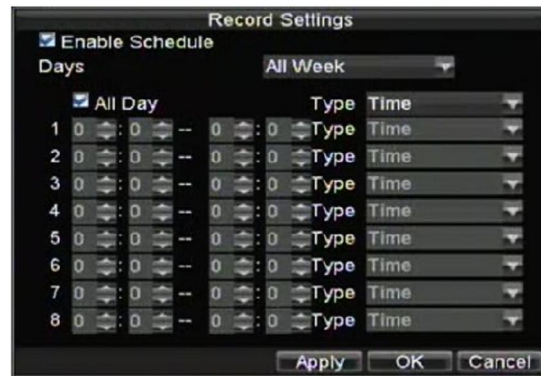

14. Click the OK button. This will take you back to the **Schedule** tab. To copy the schedule to a different channel, select the channel or all under **Copy To** and click the Copy button.

15. Click the Next button. This will take you to the **Network Settings** window shown.

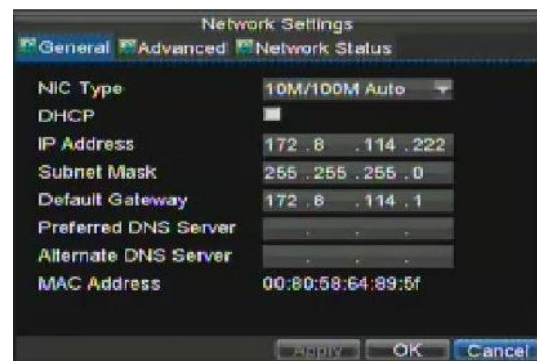

16. To configure network settings, click the Enter button.

17. Enter the **IP Address**, **Subnet Mask** and **Default Gateway**.

18. Click the OK button to return to the Setup Wizard.

19. If all the settings are entered as desired, click the Done button to finish and exit the Setup Wizard.

Congratulations. You have completed the Setup Wizard. The next step in the initial setup process is to setup the system date and time.

## 2.4 Setting Date & Time

It is extremely important to setup the system date and time to accurately timestamp recordings and events.

To setup date and time:

1. Open the Menu window by clicking the MENU button on the remote or front panel. You can also go to the Menu window by right clicking with the mouse and clicking the Menu button.
2. Click the Setting icon.
3. Click the General icon. You will be taken to the General Settings window, as shown below.

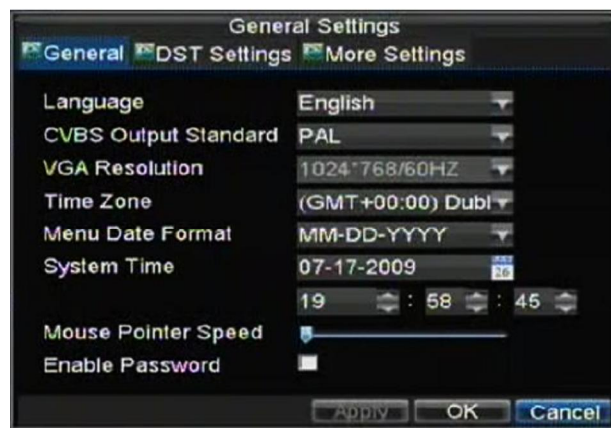

4. Enter the correct date and time under **System Time**.
5. Click the Apply button to save the settings.

## 3. Live Preview

### 3.1 Watching a Live Preview

The Live Preview mode is automatically started after the DVR boots up. It is also at the very top of the menu hierarchy, thus hitting the ESC multiple times (depending on which menu you are in) will bring you to the Live Preview mode.

### 3.2 Understanding Live Preview Icons

There are multiple icons on each display in Live Preview mode to indicate different camera status. These icons include:



**Event Icon:** Indicates video loss or tampering, motion detection and/or sensor alarm.



**Record Icon:** Indicates the current channel is recording. The recording may have been started manually, from a schedule, and/or triggered from motion or alarm.

### 3.3 Operating the Live Preview

In Live Preview mode, you can:

#### 1. Display Single Camera:

- **Using Front Panel/Remote:** Use Alphanumeric buttons.
- **Using Mouse:** Select Single Camera in right-click menu.

#### 2. Preview Layout Switch:

- **Using Front Panel/Remote:** Click PREV button.
- **Using Mouse:** Select Multi-Camera in right-click menu.

#### 3. Manual Switch:

- **Using Front Panel/ Remote:** To move to the previous screen, click the Left direction button. To move to the next screen, click the Right direction button.
- **Using Mouse:** Select Next screen in right-click menu.

#### 4. Auto Switch:

- **Using Front Panel/Remote:** Click ENTER button.
- **Using Mouse:** Select Start Sequence in right-click menu.

#### 5. Digital Zoom:

- **Using Mouse:** Select Digital Zoom in right-click menu.

### 3.4 Using the Mouse in Live Preview

Many features of the Live Preview can be quickly accessed by clicking the right-button of the mouse (shown below). These features include:

- **Single Camera:** Switch to a full screen display of the selected camera. Camera can be selected from a drop down list.
- **Multi-Camera:** Switch between different display layout options. Layout options can be selected from a drop down list.
- **Next Screen:** When displaying less than the maximum number of cameras in Live Preview, clicking this feature will switch to the next set of displays.
- **Playback:** Enter into Playback mode.
- **PTZ:** Enter PTZ Control mode.
- **Digital Zoom:** Enter Digital Zoom interface.
- **Menu:** Enter Main menu.
- **Start Auto-switch:** Enable sequencing in Live Preview mode.

**Note:** The dwell time of the preview configuration should be set before using **Start Auto-switch**.

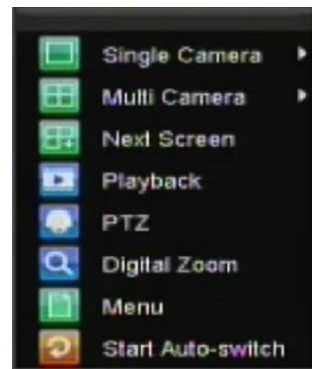

### 3.5 Using Digital Zoom

To use digital Zoom in Live Preview mode:

1. Right-click using the mouse in Live Preview mode.
2. Select Digital Zoom from Mouse menu.
3. Left-click and drag the red box to the desired area for zoom. The zoomed image will be magnified by 4x. A sample of this can be seen below.



### 3.6 Configuring Live Preview Displays

Live Preview displays can be customised to your own needs. These settings can be accessed by entering the Display Settings menu.

To access the Display Settings menu:

1. Click the MENU button.
2. Click the Settings icon.
3. Click the Display icon.

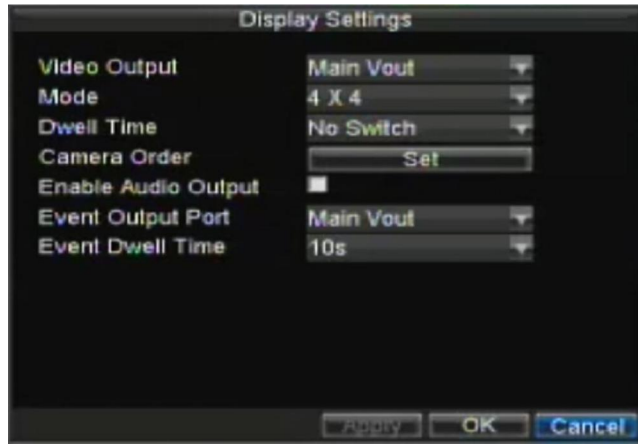

The settings available in this menu include:

- **Video Output:** Designates the output to configure the settings for. Outputs include Main Vout and Auxiliary Vout. (Vout is video out)
- **Mode:** Designates the display mode to be use for Live Preview (Spot out only one window).
- **Dwell Time:** The time in seconds to  *dwell*  between switching of channels when **Start Sequence** is selected in Live Preview.
- **Camera Order:** The order of the cameras to be used in the selected display mode (See **Setting Camera Order**).
- **Enable Audio Output:** Enable/disable audio output for the selected video output.
- **Event Output Port:** Designates the output to show event video on.
- **Event Dwell Time:** The time in seconds to show event screen.

**Note:** DVR will automatically detect if a VGA display is connected. If VGA is connected, main CVBS will not show you any images. If VGA is not connected, main CVBS will show you main GUI.

**Note:** Spot out only one window. VGA cannot work together with Main CVBS.

### 3.7 Setting Camera Order

Setting the camera order allows you to logically position cameras for more efficient monitoring of your own individual location.

**Note:** Spot out only has one window division

To set the camera order:

1. Enter the Display Settings menu, shown in Figure 5 (Menu > Setting > Display).
2. Click the Set button.
3. Select the display mode you would like to set the camera order for under **Mode**.
4. Using the up and down button at each display, select the camera you would like to set. Setting an **X** will mean the camera will not be displayed.

Click the OK button.

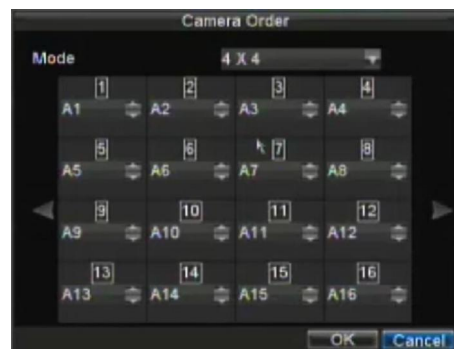



## 4. Record Settings

### 4.1 Configuring Settings for Recording

There are multiple ways to setup your DVR for recording. They include setting up a recording schedule, triggering a recording by motion detection and/or a sensor alarm, and manually starting the recording.

### 4.2 Initialising Record Settings

Before setting your DVR up for recording, certain settings should be configured first. The steps to configuring these settings are:

1. If you have not initialised a HDD either through the Setup Wizard or through HDD management, you must do so before proceeding.
2. Navigate to Menu > Setting > Record. You will be taken to the Record Settings menu, shown below.



3. Select the camera you would to configure the settings for.

4. Configure settings for:

- **Encoding Parameters:** Select the encoding parameters, either Normal or Event.
- **Stream Type:** Type of stream to record, either video or video & audio.
- **Resolution:** Select the resolution of the recording. The options include 4CIF, 2CIF, CIF and QCIF.
- **Bit Rate Type:** Select either Variable or Constant bit rate.
- **Video Quality:** Select the quality to record cameras at.
- **Frame Rate:** Select recording frame rate.
- **Max Bit Rate:** Select or define custom maximum bit rate for recordings.

5. Click the Set button under **More Settings**. This will bring up another menu with more advance recording options. See below.



6. Set additional record settings:

- **Pre-Record:** Sets the time in seconds to pre-record before the actual recording begins.
- **Post-Record:** Sets the time in seconds to post-record after the actual recording has ended.
- **Recording Expired Time:** Sets the expiration time in days for recorded video. Recordings after expiration time would be deleted. If it is set to 0 the option would be disabled.
- **Redundantly Record:** Select to enable or disable redundant recording on the particular channel.
- **Record Audio:** Select to record audio of the camera or not.

7. Click the OK button to finish and return to the previous menu.

8. Select the **Advanced** tab. This will open the Advanced settings menu.

9. Enable or disable the **Overwrite** setting. Enabling the **Overwrite** setting will cause recorded files to be overwritten once the HDD is full.

10. Click Apply and then the OK button.

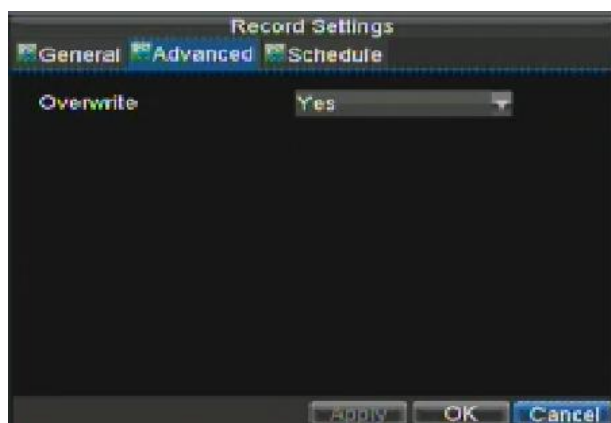



### 4.3 Scheduling a Recording

Scheduling a recording allows you to setup the DVR to only record when you want it to. To setup a recording schedule:

1. Enter the Record Settings menu (Menu > Setting > Record).
2. Select the **Schedule** tab to open the Schedule menu.

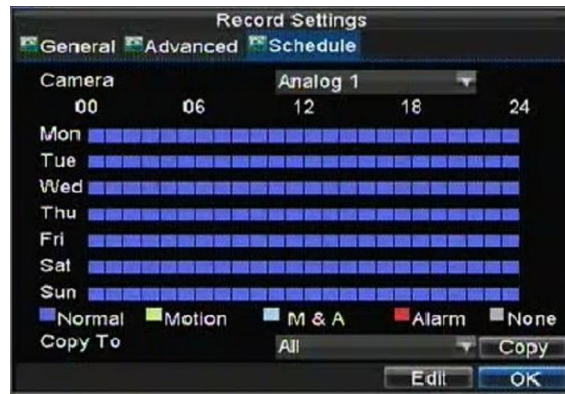

3. Select Camera to edit schedule for.
4. Click the Edit button.
5. Click and check **Enable Schedule**.
6. Select the day you would like to setup the schedule for or select All Week to record the entire week.
7. Select to record the entire day by clicking **All Day** or at different time periods. Up to 8 time periods can be scheduled. It is important to note that time periods cannot be overlapped.
8. Select recording **Type**. Recording type can be based on time and triggered by motion detection and/or alarm. Motion detected and alarm triggered recordings are further explained in **Configuring Alarms**.
9. Click the OK button to finish configuration.
10. Repeat steps 3-9 for other cameras or copy settings from one schedule to the next under the **Copy To** section.
11. Click OK to finish and save the schedule settings.

**Note:** **Event** encoding parameters will take effect when motion detection or alarm happens. **Normal** encoding parameters will take effect when there are no events happening.

### 4.4 Starting a Manual Recording

A manual recording can be started at any time. To start a manual recording:

1. Press the REC/SHOT button on the front panel or in the Main menu to bring up the Manual Record menu.



2. Start manual recording by selecting On or Off for the cameras desired.

## 4.5 Protecting Recorded Files

There are two methods to prevent recorded files from being deleted off the HDD. It is highly recommended that important recorded events be protected from deletion. Recorded files can either be **locked** or the HDD that the files reside on can be set to **read only**.

### 4.5.1 Locking and Unlocking Recorded Files

To lock or unlock a recorded file:

1. Enter the Video Search menu by navigating to Menu > Video Search. The Video Search menu is shown below.



2. Search for desired recording by entering search parameters. Search parameters include Camera number, Video/File Type, and Start/End Time.

3. Click the Search button. A list of recordings (similar to example below), matching the search parameters will be displayed.

4. Select the file you would like to lock/unlock.

5. Click on the Lock button to lock file. If the file is already locked, click on the Unlock button to unlock file. Locked files will be shown with a closed lock while unlocked files, opened lock.



6. Click Cancel to exit out of the Video Search menu.

#### 4.5.2 Setting HDD to Read-Only

To set a HDD to read-only:

1. Navigate to the HDD Management menu by going to Menu > HDD Management. The HDD Management menu is shown below.



2. Select the **General** tab.

3. Select the HDD to set to read-only.

4. Click the Property button. This will take you to the Property Settings menu.

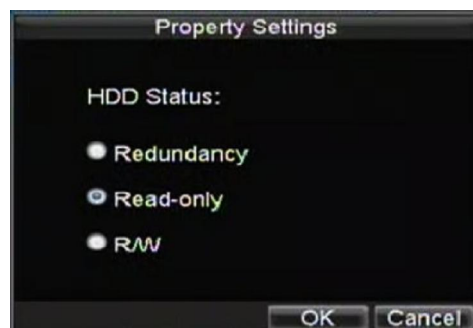

5. Set HDD to Read-Only.
6. Click the OK button. The HDD is now read-only.

**Note:** When a HDD is set to **read-only**, no more recordings can be written to the disk. In order to enable recordings on that particular disk again, you must set the HDD to R/W (Read/ Write) in the HDD Property Settings menu. If multiple HDDs are used, the DVR will automatically record to the next HDD that is not set to **read-only**.

## 4.6 Configuring Advanced HDD Settings

### Setting up HDD Redundancy

To insure unexpected failures of hard disk drives, it is recommended to set up HDD redundancy. It is important to note that in order to set up HDD redundancy, you will need more than one HDD in your DVR.

To set up HDD redundancy:

1. Navigate to the HDD Management menu by clicking Menu > HDD management.
2. Click on the **General** tab.
3. Select the HDD to be used for redundancy as shown below.



4. Click the Property button. This will take you to the Property Settings menu.
5. Set **HDD Status** to Redundancy as shown below. Verify at least one other HDD is set to R/W (read/write).
6. Click the OK button to save settings and return to the previous menu.

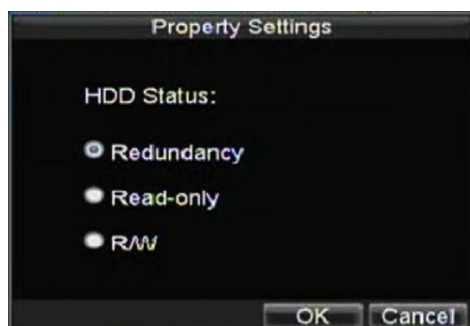

7. Navigate to the Record Settings menu by clicking Menu > Setting > Record Setting.
8. Click on the **General** tab.
9. Select the **Camera** to be used for redundancy.
10. Next to **More Settings**, click on the Set button. This will bring up additional settings for the selected camera as shown below.



11. Set **Redundantly Record** to Yes.
12. Click the OK button to save settings.
13. Repeat steps 8-12 for other cameras you would like to redundantly record.

## 5. Playback

### 5.1 Playing Back a Recording

You must first search for recordings to play them back. There are multiple ways to search for recordings, including searching for them by time, by channel, by file type and by log.

### 5.2 Understanding the Playback Interface

There are various controls on the Playback interface that makes viewing recordings more efficient. A screenshot of the Playback interface is shown below.



The Playback Control Panel, shown below contains the various controls on the Playback interface.

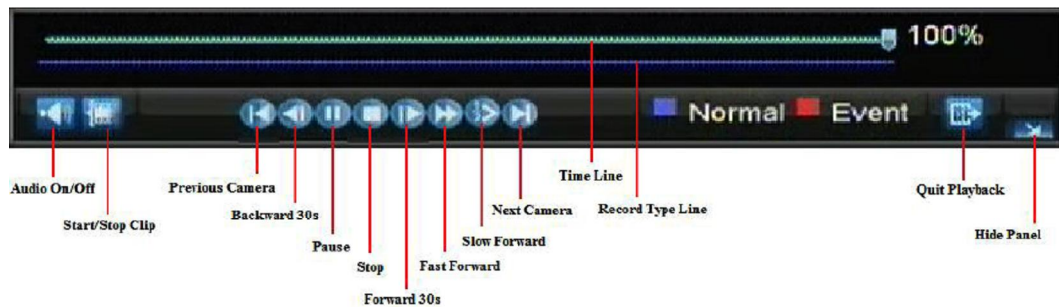

**Note:** A blue Record Time Line designates schedule/manual recording while a red one shows event recordings.

### 5.3 Playing Back from Search

To playback files from a video search:

1. Enter into the Video Search menu by clicking Menu > Video Search.
2. Set the search parameters by selecting cameras to search, video/file type and the start/end time (as shown below).

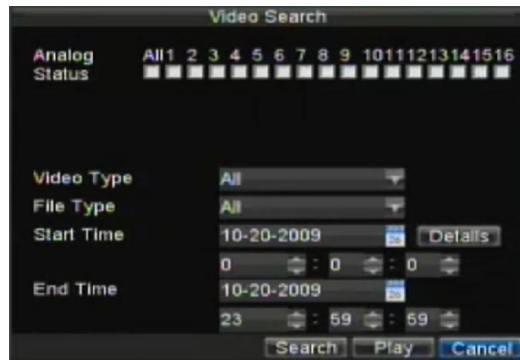

3. Click the Play button to start playback of all the files found with the specified search criteria or click the Search button to bring up the list of search results. After search results are presented, select the file you would like to playback and press Play.
4. Recordings will automatically be play backed in the Playback interface shown.



### 5.4 Playing Back from Live Preview

You may also instantly playback from a channel while watching a Live Preview. The playback will be of recordings from the past 5 minutes.

To playback from a channel instantly in Live Preview:

#### Using a Mouse:

1. Right-click the mouse on desired channel and select the Playback button.

2. Recordings from the selected channel will start playing back in the Playback interface. An **Attention** message will appear if there are no recordings found from the previous 5 minutes. You may also press the Play button to view the days recording for the selected channel.
3. You may also select additional channels (up to 16 channels) for playback from the channel list on the right hand side of the Playback interface.



#### Using the Front Panel/Remote:

1. Press the PLAY button. This will take you into the Playback interface.
2. Enter the channel you would like to watch recordings for on the front panel or remote (i.e. press 0 then 4 for channel 04).
3. Recordings will begin for the selected channel.

### 5.5 Playing Back from System Log

You may also playback recordings from the System Log.

To playback video from the System Log:

1. Enter the Log Search menu by clicking Menu > Maintenance > Log Search.





2. Set **Major Type** setting to **Information**.
3. Set **Minor Type** setting to **Start Record** or **End Record**.
4. Set **Start Time** and **End Time**.
5. Click the Search button.
6. A list of results with your search criteria will be returned. Select the video log to playback and click Play.
7. The recording will begin to play in the Playback interface.

## 5.6 Playing Back Frame-by-Frame

To playback frame-by-frame in the Playback interface:

### • Using a Mouse:

1. Click the Slow Forward button on the Playback Control Panel until the speed changes to **Single** frame.
2. Click the Pause button to advance the video frame by frame.

### Using the Front Panel/Remote:

1. Rotate the inner control on Jog Shuttle anticlockwise or press the Down button to set the play to **Single** frame.
2. Press the OK button.
3. Press the Enter button to advance the video frame by frame.

## 5.7 Using Digital Zoom

To use digital zoom in Playback mode:

1. Enter Digital Zoom mode by right-clicking with the mouse in Playback and selecting Zoom.
2. Left-Click and drag red box for desired magnification area, as shown below. The selected area will be zoomed to full screen.



## 6. Backup

### 6.1 Backing up Recorded Files

Recorded files can be backed up to various devices, such as USB flash drives, USB HDDs or a DVD writer.

### 6.2 Exporting Files

To export recorded files:

1. Enter the Export Video menu (shown below) by clicking Menu > Video Export.



2. Select desired parameters to search for files to export.
3. Press the Export button. This will take you to the Video Search menu.
4. Select the files to export, as shown below. You may also click the Play button to verify that these files are indeed the ones you would like to export.



5. The size of the currently selected files is displayed in the lower-left corner of the window. Select the Next button to enter the Export menu, shown below.



6. Select device to export to from drop-down list (USB Flash Drive, USB HDD, DVD Writer). If backup device is not recognised:

- Click the Refresh button.
- Reconnect device.
- Check for compatibility from vendor.

7. Click Start to begin backup process.



8. After the backup process has completed see below, you may select the files from your device and click the Play button to verify that it has been exported successfully.



**Note:** Video Player software will automatically be copied on to the device that the recorded files were exported on.

### 6.3 Exporting Video Clips

You may also select video clips to export directly during Playback. A maximum of 30 clips can be selected for each channel.

To export video clips during Playback:

#### Using the Mouse:

1. Enter into the Playback interface (See **Playing Back a Recording**).
2. Using the Clip Start/Stop button in the Playback Control Panel, select the start and end of the video clip during playback.
3. Repeat for additional clips.
4. Click the Quit Playback button to exit from the Playback interface. You will then be prompted to save the clips, as shown below.



5. Click the Yes button to enter Backup interface or select No to exit to Playback interface.
6. At the Backup interface, select the Start button to begin the Backup process.

#### • Using the Front Panel / Remote:

1. Enter into the Playback interface (See **Playing Back a Recording**).
2. During playback, press the EDIT button to mark start of clip.
3. Press the EDIT button again to mark end of clip.
4. Repeat for additional clips.
5. Press the ESC button to exit from the Playback interface. You will then be prompted to save the clips, as shown above.
6. Click the Yes button to enter Backup interface or select No to exit to Playback interface.
7. At the Backup interface, select the Start button to begin the Backup process.

## 6.4 Managing Backup Devices

To manage backup devices, you must first be in the Export menu, shown. The Export menu can be accessed by following the steps shown in the previous section (See **Exporting Files**).



Once in the Export menu, you may:

- **Create New Folder:** Creates a new folder on the export device.
- **Delete:** Delete a file or folder from the export device.
- **Play:** Play the selected video file from the export device.
- **Format:** Format the export device.
- **Erase:** Erase files from a re-writable CD/DVD.

## 7. Alarm Settings

### 7.1 Configuring Alarms

#### 7.1.1 Setting up Motion Detection

Set up properly, using a motion detection recording will increase the number of days your DVR is able to record. It will only record relevant events rather than recording everything, making searching for an event easier.

To set up motion detection:

##### 1. Enter Camera Setting:

Enter the Camera Settings interface by navigating to Menu > Setting > Camera. Select channel to configure motion detection on.

2. Select the **Advanced** tab to open up the Advanced Camera Settings menu, shown below.

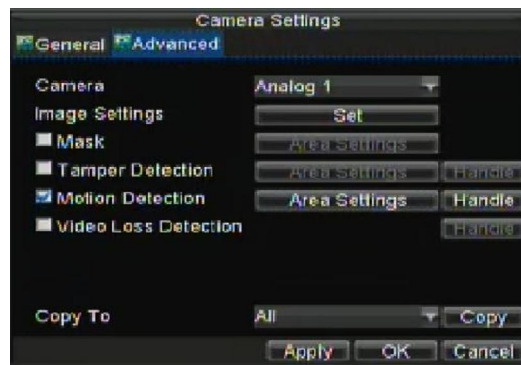

3. Tick the checkbox to the left of Motion Detection.

4. Click the Area Settings button to enter the Motion Detection area and Sensitivity configuration interface.

5. The Motion Detection area, shown below, allows you to mask out areas where you would like motion to be detected in. The maximum area is the whole screen. Mask the Motion Detection area.

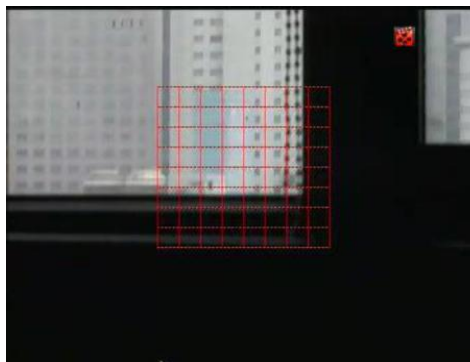

6. Set the Motion Detection Sensitivity, shown in Figure 3. The higher the sensitivity value, the higher the sensitivity.



7. Click OK to return to the Camera Settings menu.

8. Click the Handle button to open the Exception Handle menu, shown below. Select the Triggered Camera tab.

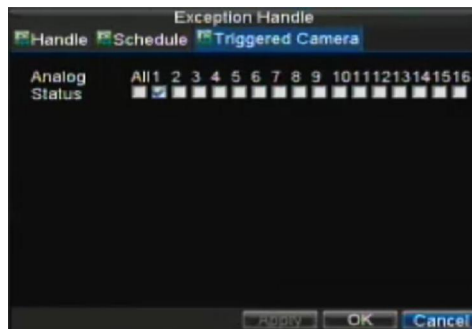

9. Select cameras to trigger for recording when motion is detected by ticking the checkboxes under the desired camera numbers.

10. Click OK to complete motion settings for the selected camera.

You may now add a schedule to start recording when motion is detected (See **Scheduling a Recording**).

### 7.1.2 Setting up Sensor Alarms

Recordings can also be triggered from an external sensor alarm device. To setup sensor alarms:

1. Enter into the Alarm Management menu by navigating to Menu > Setting > Alarm, shown below.

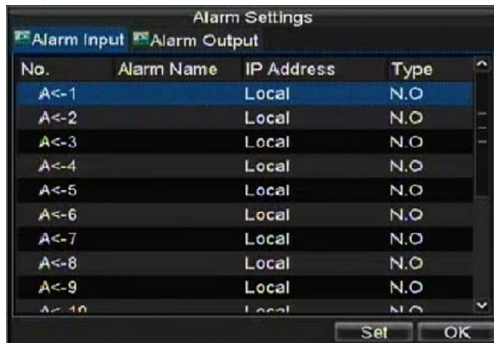

2. Select the **Alarm Input** number and click the Set button. This will open the Alarm Input Setting menu, shown below.

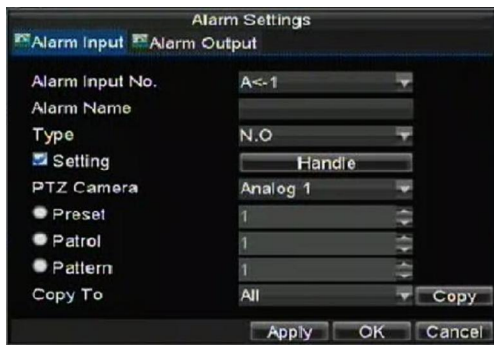

3. Set the alarm input type under **Type**. The options available are Normally Open (N.O.) and Normally Closed (N.C.).

4. Tick the checkbox next to **Setting** and click the Handle button to enter the Alarm Input Handle menu.

5. Select the **Triggered Camera** tab.

6. Select cameras to trigger for recording when alarm occurs by checking the checkboxes under the desired cameras, as shown below.

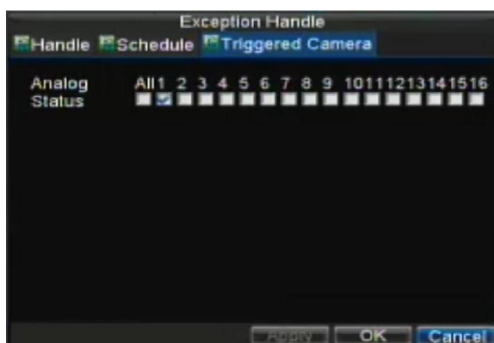

7. Click the OK button to complete setup.



You may now add a schedule to start recording when an alarm is triggered (See **Scheduling a Recording**).

Alarm outputs may also be configured in the Alarm Management menu. To set up Alarm Output:

1. Select the **Alarm Output** tab. This will bring up the Alarm Output interface, shown below.

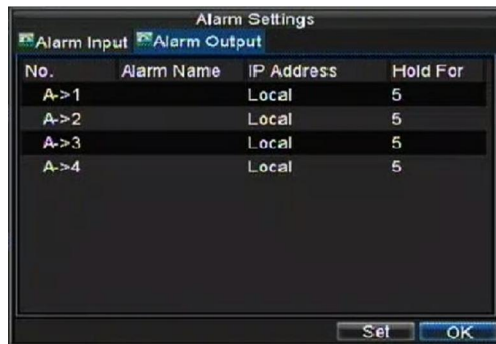

2. Select the output you would like to configure and click the Set button. This will bring up the settings page for the selected channel.

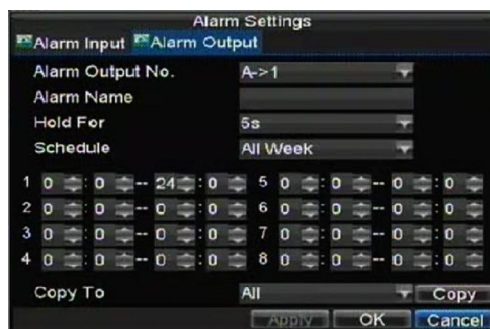

3. Configure the settings for selected output.

4. Select OK to save and exit.

**Note:** If the **Hold For** option is selected as **Manually Stop**, the alarm will only stop when you manually stop it (See **Triggering Alarm Outputs Manually**).

### 7.1.3 Triggering Alarm Outputs Manually

You may also trigger alarm outputs manually through the Manual Alarm menu.

To trigger alarm outputs manually:

1. Enter the Manual Alarm menu by clicking Menu > Manual Alarm.



2. In the Manual Alarm menu, you may:

- **Trigger:** Select an alarm from the list and click Trigger to trigger its output.
- **Trigger All:** Trigger all alarm outputs at once.
- **Clear All:** Stop all alarm outputs at once.

3. Select OK to return to the previous menu.

## 7.2 Detecting Video Loss

Your DVR can be setup to detect video loss and trigger an action. To setup video loss detection:

1. Enter Camera Settings menu by clicking Menu > Setting > Camera.
2. Select camera under **Channel number** to configure video loss detection and click the Set button.
3. Select the **Advanced** tab.
4. Tick the **Video Loss Detection** checkbox to enable feature, as shown below.



5. Click the Handle button to enter the Exception Handle menu, shown in Figure 12.

6. Select the **Handle** tab to configure exceptions handling. Exception trigger options are further explained in the next section (See **Understanding Exception Trigger Options**).

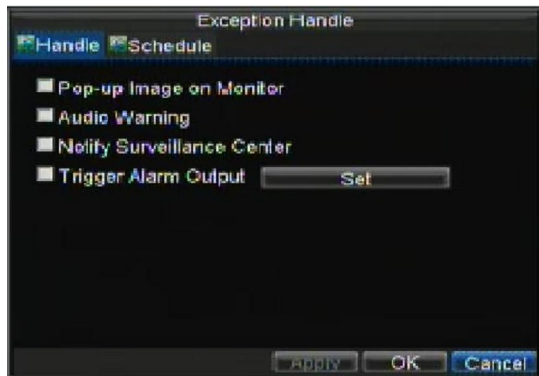

7. Select the **Schedule** tab. Set the schedule of when you want video loss detection to be enabled. Schedule can be set for all week or any day of the week with up to 8 time periods per day.

8. Click the **Apply** button to finish.

9. Repeat above for other channels.

### 7.3 Detecting Video Tampering

Video tampering (i.e. moving camera to a different position) can also be detected and set to trigger an action on your DVR. To setup video tampering detection:

1. Enter Camera Management/Settings menu by clicking Menu > Setting > Camera.

2. Select camera under **Channel number** to configure video loss detection or and click the Set button.

3. Select the **Advanced** tab.

4. Check the **Tamper Detection** checkbox, as shown below.

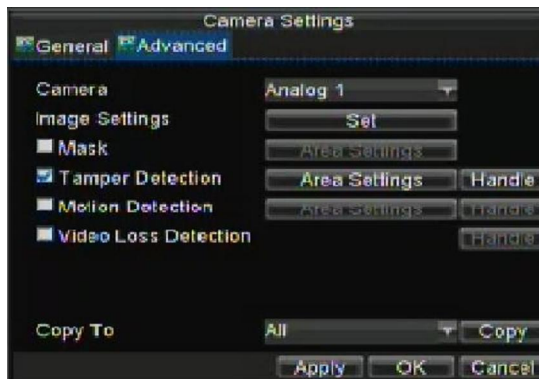

5. Click the Area Settings button to enter the area setup.

6. Setup tampering area, as shown. Only one tampering area can be set, with the full screen being the maximum area.



7. Set detection sensitivity. The higher the value set, the higher the sensitivity.
8. Click OK to return to the Camera Settings/Management menu.
9. Click the Handle button to enter the Exception Handle menu, shown below.

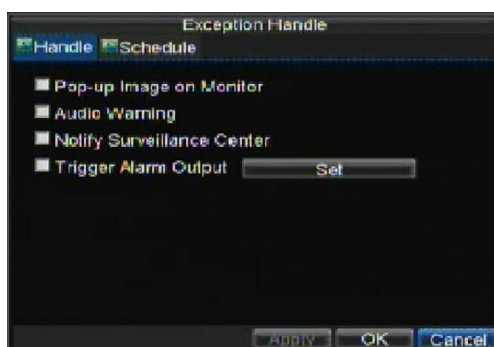

10. Select the **Handle** tab to configure exceptions handling. Exception trigger options are further explained in the next section (See **Understanding Exception Trigger Options**).
11. Select the **Schedule** tab. Set the schedule for when you want video loss detection to be enabled. Schedule can be set for all week or any day of the week with up to 8 time periods per day.
12. Click the Apply button to finish.
13. Repeat above for other channels.

#### 7.4 Setting Exceptions

Setting exceptions allow the DVR to alert you when irregular events occur. These events include:

- **HDD Full:** All installed HDDs are full.
- **HDD Errors:** Errors occurred during writing of the HDD or HDD has failed to initialise.

- **Network Disconnected:** Disconnected network cable.
- **IP Conflicted:** Conflict in IP address setting.
- **Illegal Login:** Wrong user ID or password used.
- **Video Exception:** Instable video signal detected.
- **Mismatched Output Standard Mismatch:** I/O video standards do not match.

To set exceptions:

1. Enter the Exception menu by clicking Menu > Exception.
2. Select the exception to configure under **Exception Type**.
3. Select triggering options, as shown below.

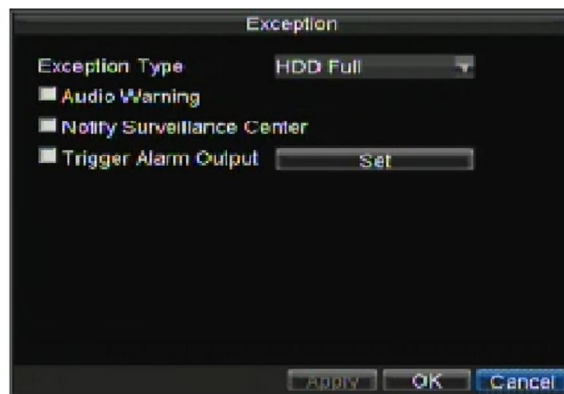

Trigger options are further explained in the next section (See **Understanding Exception Trigger Options**).

4. Click OK to save and exit Exception menu.

## 7.5 Understanding Exception Trigger Options

When setting up exception handlers for such features as motion detection and sensor alarms, you may select triggering options to alert you of these exceptions.

The triggering options that you may select include:

**Pop-up Image on Monitor:** When an alarm is triggered, the local monitor (VGA or BNC monitor) will display an image under Live Preview mode. This alarm can be configured under the Popup Alarm Image handle method. For alarms that are triggered simultaneously, images will be displayed one at a time every 10 seconds (default dwell time). A different dwell time can be set by going to Menu > Setting > Display > Dwell Time. Once the alarm stops, cycling of the images will also stop and you will be returned to the Live Preview screen.

- **Audio Warning:** Trigger an audible **beep** when exception is detected.
- **Notify Surveillance Center:** Sends a signal to remote alarm host when exception is detected (See **Configuring a Remote Alarm Host**).
- **Trigger Alarm Output:** Trigger an alarm output when exception is detected. Alarm output can be configured by following the steps listed in **Setting Up Sensor Alarms**.

## 8. Network Settings

### 8.1 Configuring Network Settings

Network settings must be configured before you are able to use your DVR over the network.

### 8.2 Configuring Basic Settings

To configure basic network settings:

1. Enter the Network Settings menu, shown in Figure 1 by clicking Menu > Setting > Network.

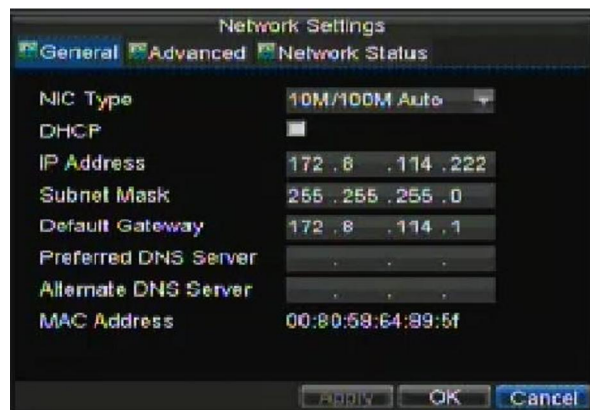

2. Select the **General** tab.

3. If you have a DHCP server running and would like your DVR to automatically obtain an IP address and other network settings from that server, check the **DHCP** checkbox. You may check the DHCP status by going to the **Network Status** tab, as shown below.

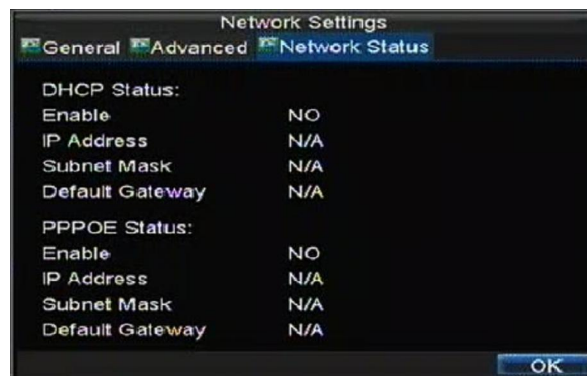

4. If you would like to configure your own settings, enter the settings for:

- **IP Address:** IP address you would like to use for your DVR.
- **Subnet Mask:** Subnet Mask of network.
- **Default Gateway:** IP address of your Gateway. Typically the IP address of your router.
- **Preferred/Alternate DNS Server:** The preferred and alternate Domain Name System (DNS) Server to be used with your DVR.

5. Click OK to save and exit the Network Settings menu.

### 8.3 Configuring PPPoE Settings

Your DVR also allows for Point-to-Point Protocol over Ethernet (PPPoE) access. This option however is not generally available in the UK which uses PPPoA. Therefore PPPoE is not documented.

### 8.4 Configuring DDNS

To setup DDNS:

1. Enter the Network Settings menu by clicking Menu > Setting > Network.
2. Select the **Advanced** tab.
3. Select the Set button next to **DDNS** to enter the DDNS settings menu, shown below.



The screenshot shows the DDNS configuration window. The 'DDNS' checkbox is checked. The 'DDNS Type' dropdown is set to 'PeanutHull'. The 'Server Address' field is empty. The 'DVR Domain Name' field contains 'test.vicp.net'. The 'User Name' field contains 'test'. The 'Password' and 'Confirm Password' fields are masked with asterisks. 'OK' and 'Cancel' buttons are at the bottom right.

4. Check the **DDNS** checkbox to enable feature.
5. Select **DDNS Type**. There are three different DDNS type to choose from, IpServer, PeanutHull and DynDNS.
  - **IpServer:** Enter **Server Address** for IpServer.
  - **PeanutHull:** Enter **User Name** and **Password** obtained from the PeanutHull website.



The screenshot shows the DDNS configuration window. The 'DDNS' checkbox is checked. The 'DDNS Type' dropdown is set to 'DynDns'. The 'Server Address' field contains 'members.dyndns.org'. The 'DVR Domain Name' field contains 'test.website.com'. The 'User Name' field contains 'test'. The 'Password' and 'Confirm Password' fields are masked with asterisks. 'OK' and 'Cancel' buttons are at the bottom right.

- **DynDNS:** Enter **Server Address** for DynDNS (i.e. members.dyndns.org). Under DVR Domain Name, enter the domain obtained from the DynDNS web site. Lastly, enter the **User Name** and **Password** registered in the DynDNS network.

## 8.5 Configuring an NTP Server

A Network Time Protocol (NTP) Server may also be setup on your DVR to keep the date and time current and accurate.

To setup an NTP server:

1. Enter the Network Settings menu by clicking Menu > Setting > Network.
2. Select the **Advanced** tab.
3. Select the Set button next to **NTP** to enter the NTP settings menu, as shown below.



4. Check the **NTP** checkbox to enable feature.
5. Set NTP settings:
  - **Synchronize Every:** Time in minutes to synchronise with NTP server.
  - **NTP Server:** IP address of NTP server.
6. Click OK to save and exit menu.

**Note:** Time synchronisation interval has a range of 0-10080ms, normally 7200ms. If the DVR is used on a public network, you should use an NTP server that has a time synchronisation function, such as the server at the National Time Center (IP Address: 210.72.145.44). If the DVR is setup in a more customised network, NTP software can be used to establish an NTP server used for time synchronisation.

## 8.6 Configuring a Remote Alarm Host

With a remote alarm host set, the DVR will send a signal to the host when an alarm is triggered. The remote alarm host must have the Network Video Surveillance software installed.

To set up a remote alarm host:

1. Enter Network settings menu by clicking Menu > Setting > Network.
2. Select the **Advanced** tab.
3. Click the Set butt next to **Host/Others** to enter the Host/Others menu, as shown below.



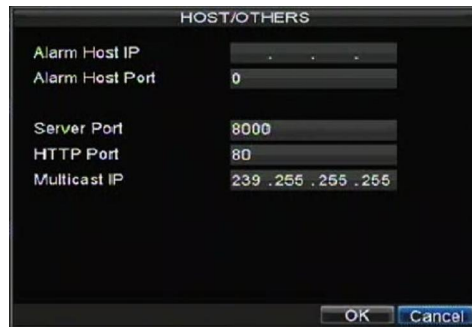

4. Enter **Alarm Host IP** and **Alarm Host Port**. Alarm Host IP is the IP of the remote PC which has the Network Video Surveillance software installed. The Alarm Host Port must be the same as software alarm monitor port (default port is 7200).

### 8.7 Configuring Multicast

Setting up multicasting solves limitation issues when streaming videos through a network access device. A multicast address spans the Class-D IP range of 224.0.0.0 to 239.255.255.255. It is suggested that the IP address range of 239.252.0.0 to 239.255.255.255 be used.

To set up multicasting:

1. Enter the Network Settings menu by clicking Menu > Setting > Network.
2. Select the **Advanced** tab.
3. Click the Set button next to **Host/Others** to enter the Host/Others menu.
4. Set **Multicast IP**, as shown below. When adding a device to the Network Video Surveillance software, the multicast address must be the same as the DVR's multicast IP.

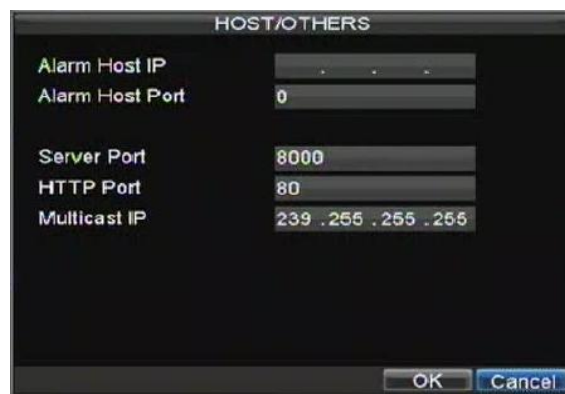

5. Click OK to save and exit menu.

## 8.8 Configuring Server and HTTP Ports

If you would like to change the server and HTTP ports from the default settings, you can do so in the Network Settings menu. The default server port is 8000 while the default HTTP port is 80.

To change the default ports:

1. Enter the Network Settings menu by clicking Menu > Setting > Network.
2. Select the **Advanced** tab.
3. Click the Set button next to **Host/Others** to enter the Host/Others menu.
4. Enter new **Server Port** and **HTTP Port**, as shown.

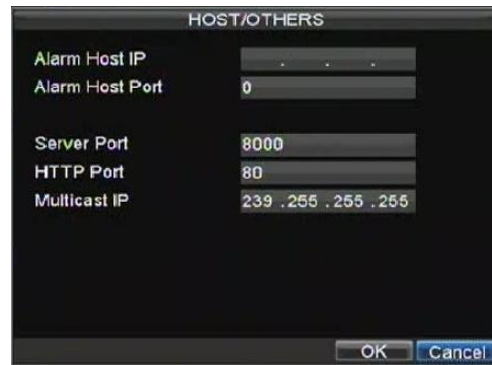

**Note:** The Server Port has a port range of 2000-65535 and is used for remote client software access. The HTTP port is used for remote internet browser access.

## 9. PTZ Controls

### 9.1 Navigating PTZ Menu

PTZ menus can be navigated through with either the mouse or the front panel/remote. For quick access to certain PTZ settings, right clicking with the mouse in a display while in PTZ control mode will bring up the PTZ settings menu. This menu is shown below.

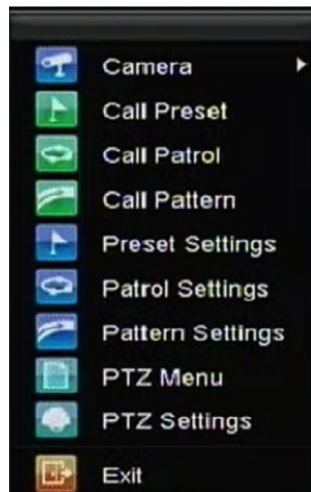

The items that can be found on this menu include:

- **Camera:** Select a PTZ camera.
- **Call Preset:** Call a PTZ preset.
- **Call Patrol:** Call a PTZ sequence.
- **Call Pattern:** Call a PTZ pattern.
- **Patrol Setting:** Enter PTZ sequence configuration menu.
- **Pattern Setting:** Enter PTZ pattern configuration menu.
- **PTZ Setting:** Enter PTZ setting menu.

### 9.2 Configuring PTZ Settings

Settings for a PTZ camera must be configured before it can be used. Before proceeding, verify that the PTZ and RS-485 of the DVR are connected properly.

To configure PTZ settings:

1. Enter the PTZ Settings menu by clicking Menu > Setting > PTZ.

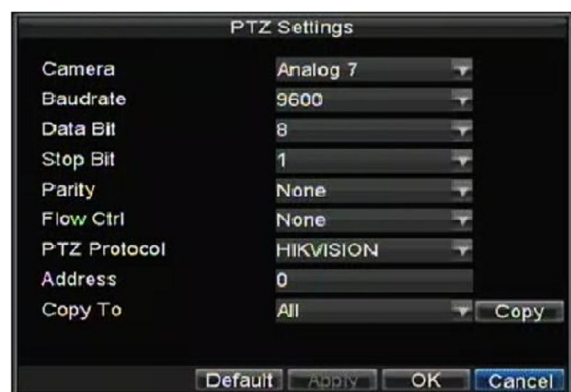

2. Select channel where PTZ camera is installed next to **Camera** label.
3. Enter PTZ settings so it matches that of the PTZ camera.
4. Click OK button to save and exit menu.

### 9.3 Setting PTZ Presets, Patrols & Patterns

Your DVR allows you to customize presets, patrols and patterns for a connected PTZ camera. Before setting presets, patrols and patterns, it is important to understand some of the features of the PTZ control panel, shown below.



#### Interface

The controls on the PTZ panel include:

1. **Directional Pad/Auto-scan Buttons:** Controls the movements and directions of the PTZ. Center button is also used to start auto-scan of PTZ.
2. **Zoom:** Used to zoom in and out with the PTZ.
3. **Focus:** Used to adjust the focus of the PTZ.
4. **Iris:** Used to open up or close the iris of the PTZ.
5. **Speed:** Adjusts the movement speed of the PTZ.
6. **Light:** Turns PTZ light (if applicable) on and off.
7. **Wiper:** Turns PTZ wiper (if applicable) on and off.
8. **Zoom In:** Instantly zooms PTZ in.
9. **Center:** Centers PTZ.

#### 9.3.1 Customising Presets

Presets can be set to move your PTZ camera to a desired **preset** location at the click of a button.

To setup and use custom PTZ presets:

1. Enter the PTZ Control interface, shown in figure 9.1 by clicking PTZ in the menu or the PTZ button on the front panel.
  2. Select the Preset button to enter the Preset Management menu.
  3. In the Preset Management menu, shown below, you may:
    - Configure Preset:** Use the PTZ control panel to adjust the position of the preset. Select a Preset number and click the Set button to save preset location.
    - Clear Preset:** Select a Preset number and click the Clear button to delete the preset. You may also select the Clear All button to delete all presets.
    - Call Preset:** Select a Preset and click the Call button.
- Note:** Only valid presets can be called and deleted.

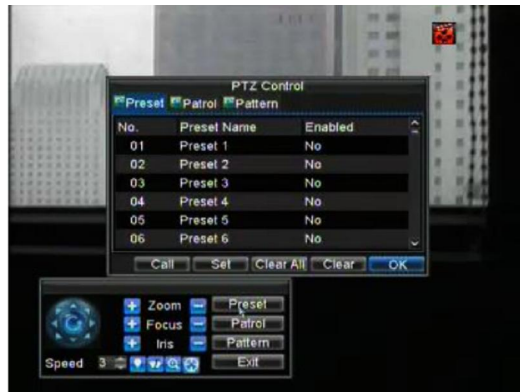

### 9.3.2 Customising Patrols

Patrols can be setup to move the PTZ to different key points and have it stay there for a set duration before moving on to the next point. The key points are defined by presets which can be set following the steps above in **Customising Presets**.

To set up and use PTZ patrols:

1. Enter the PTZ Control interface, shown in figure 9.1 by clicking PTZ in the mouse menu or the PTZ button on the front panel.
2. Select the Patrol button to enter the Patrol Management menu, shown below.

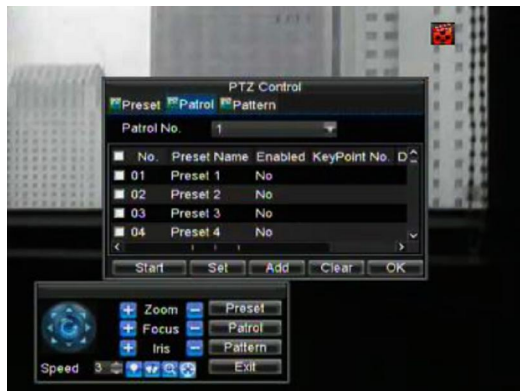

3. In the Patrol Management menu, you may:

#### Configure Patrol:

1. Select a **Patrol Number** to set.
2. Select valid presets (See **Customising Presets**) and click the Set button to enter the Patrol configuration menu. A sequence should have at least 2 valid presets.
3. Set the **Key Point No.**, **Duration**, and **Speed** (see below). The **Key Point No.** determines the order at which the PTZ will follow while cycling through the patrol. The **Duration** refers to the time span to stay at the corresponding key point. The **Speed** defines the rate at which the PTZ will move from one key point to the next.

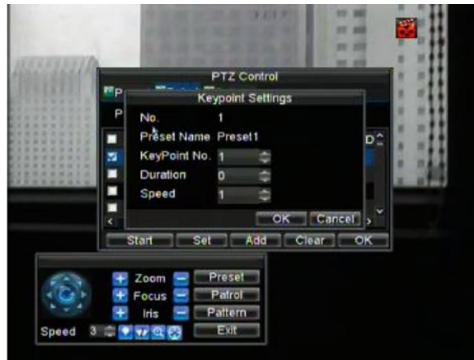

4. Click OK to return to Patrol Management menu and repeat steps 2-3 to configure other key points.
5. After all key points have been configured, click OK to save and exit menu.

#### **Clear Patrol:**

1. Select a valid **Patrol Number**.
2. Click the Clear button to delete patrol.

#### **Call Patrol:**

1. Select a valid **Patrol Number**.
2. Click the Start button to call the patrol, select the stop button to stop the patrol, as shown below

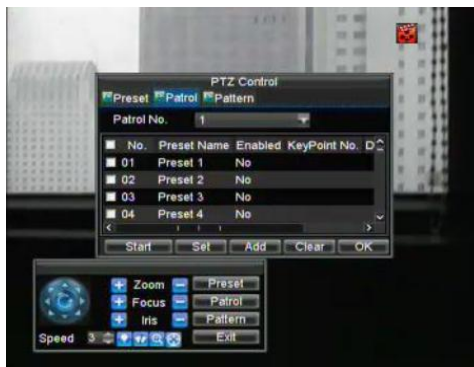

### **9.3.3 Customising Patterns**

Patterns can be setup by recording the movement of the PTZ.

To setup and use PTZ patterns:

1. Enter the PTZ Control interface, shown in figure of 9.1 by clicking PTZ in the menu or the PTZ button on the front panel.
2. Select the Pattern button to enter the Pattern Management menu, shown below.



**3. Select a **Pattern Number**.**

**4. To record a new pattern, select the Run Record button to start recording of the movements of the PTZ. Use the PTZ control panel to move the PTZ. The PTZ movements will be recorded until the Stop Record button is clicked.**

**5. To run a pattern, click the Run Pattern button on a valid pattern. The PTZ will move according to the path that was defined until Stop Pattern is clicked.**

**6. Click OK to save and exit from menu.**

## 10. Camera Management

### 10.1 Configuring OSD Settings

On Screen Display (OSD) settings can be configured in the Camera Management menu. The OSD is shown in each display during Live Preview mode and includes the time and date as well as the camera name.

To configure OSD settings:

1. Enter the Camera Management/Settings menu, shown below by clicking Menu > Setting > Camera.
2. Select channel to setup OSD settings under **Channel number**. Click the Set button.
3. Configure desired OSD settings.



### 10.2 Setting up Privacy Mask

You may setup privacy mask to mask off sensitive or private areas in the field of view of a camera.

**To setup privacy mask:**

1. Enter the Camera Management/Settings menu, shown above by clicking Menu > Setting > Camera.
2. Select channel to setup privacy mask under **Channel number**.
3. Select the **Advanced** tab to enter the Advanced Camera Settings menu, shown below.

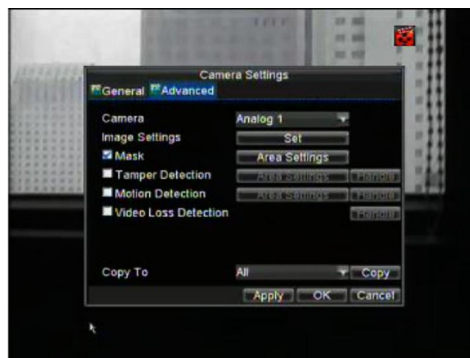



4. Tick the **Mask** checkbox to enable feature.
5. Click the Area Settings button to enter Area Settings menu.
6. Setup mask area, as shown below. Up to 4 areas can be set.



7. Select OK to save and exit mask setup.

### 10.3 Adjusting Display Settings

Display settings such as the brightness, contrast, saturation and hue can also be adjusted in the Camera Management menu.

#### To adjust display settings:

1. Enter the Camera Settings menu by clicking Menu > Setting > Camera.
2. Select channel to adjust display settings under **Channel number**.
3. Select the **Advanced** tab to enter the Advanced Camera Settings menu, shown in 10.1.
4. Click the Set button next to the Image Settings tab.
5. Adjust the display settings, as shown below. Brightness, contrast, saturation and hue can be adjusted. The adjustments of display settings not only affect previewed images, but also recorded images.



## 11. HDD Management

### 11.1 Initialising HDDs

A newly installed hard disk drive (HDD) must be first formatted before it can be used with your DVR. Formatting the HDD will erase all data on it.

To format a HDD:

1. Enter the HDD Management menu, shown below by clicking Menu > HDD.



2. Select HDD to format.
3. Click the Init (Initialise) button.
4. Select OK button to begin initialisation. After the HDD has been initialised, the status of the HDD will change from **Abnormal** to **Normal**.

### 11.2 Setting HDD Groups

Your DVR can separate multiple HDDs into groups. Videos from specified channels can be set to be recorded onto a particular HDD group.

To setup an HDD group:

1. Enter the HDD Management menu by clicking Menu > HDD.
2. Select HDDs to be added to group.
3. Select Group button to enter Group Settings menu.
4. Set the **HDD Group Number**, as shown below.



5. Select OK to save and exit menu.
- Note:** By default, all HDDs belong to group 1.

### 11.3 Setting HDD Status

You may change the behavior of your HDD by changing its status. The status of a HDD can be set to redundancy, read-only or read/write (R/W).

#### 11.3.1 Setting HDD to Read-Only

A HDD can be set to read-only to avoid important recorded files from being overwritten when the HDD becomes full.

To set a HDD to read-only:

1. Enter the HDD Management menu by clicking Menu > HDD.
2. Select HDD to protect.
3. Select the Property button to enter the Property Settings menu, as shown below.

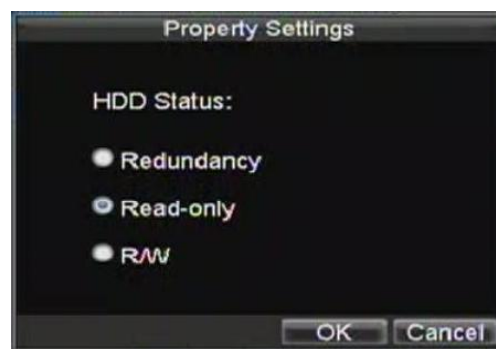

4. Set **HDD Status** to **Read-Only**.
5. Select OK to save and exit menu.

**Note:** Once set to read-only, the HDD cannot be written to until it is set back to read/write (R/W). If the HDD that is currently being written to is set to read-only, the data will be recorded to the next HDD. If there is only one HDD present, setting it to read-only will cause the DVR to not record.

#### 11.3.2 Setting HDD to Redundancy

In order to use HDD redundancy on your DVR, you will need to have at least two disks installed. Setting up HDD redundancy will allow your DVR to redundantly record a copy of the videos onto multiple drives as a safeguard against losing all your files in case of disk failures.

To setup HDD redundancy:

1. Enter the HDD Management menu by clicking Menu > HDD.
2. Select HDD to setup redundancy on.
3. Select the Property button to enter the Property Settings menu, as shown above.
4. Set **HDD Status** to **Redundancy**.
5. Select OK to save and exit menu.

**Note:** The HDD that is set to redundancy is used to store an extra copy of the recording. If a HDD is set to redundancy, at least one HDD should be set to the R/W status.

## 11.4 Checking HDD Status

You may check the status of any of the installed HDDs on your DVR at anytime.

To check the status of an HDD:

1. Enter the HDD Management menu by clicking Menu > HDD.
2. The status of your HDD is listed under the **Status** column. If the status is listed as **Normal** or **Hibernate**, the HDD is in working order. If it is listed as **Abnormal** and has already been initialised, the HDD needs to be replaced. If the HDD is **Uninitialised**, you will need to initialise it before it can be used in your DVR. Please refer to **Initialising HDDs** for further instructions.

You may also view the SMART information on installed HDDs. SMART, short for Self-Monitoring, Analysis and Reporting Technology is a monitoring system for hard disk drives to detect and report on various indicators of reliability in the hopes of anticipating failures.

To view SMART information of a HDD:

1. Enter the Log Search menu, shown below by clicking Menu > Maintenance > Log.



2. Set **Major Type** to **Information**.
3. Set **Minor Type** to **HDD SMART**.
4. Enter **Start Time** and **End Time**.
5. Click the Search button to begin log search. A result list, similar to that below will be returned.

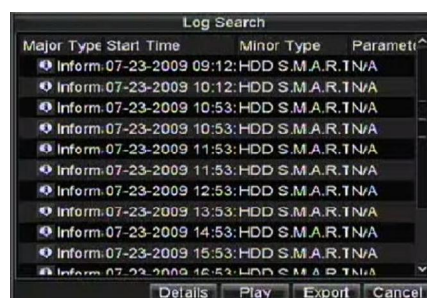

6. Select log item to view and click the Details button.
7. A detail listing of SMART information, as shown below will be displayed.



## 11.5 Configuring HDD Alarms

HDD alarms can be set to trigger when an HDD is uninitialised or in an abnormal state.

To set HDD alarms:

1. Enter Exception menu, shown below by clicking Menu > Exception.



2. Select HDD Error under **Exception Type**.
3. Select trigger action. Trigger actions are further explained in **Understanding Exception Trigger Options**.

## 12. DVR Management

### 12.1 Configuring General Settings

General settings such as the system language can be configured in the General Settings menu of your DVR.

To configure general settings:

1. Enter the General Settings menu, shown below by clicking Menu > Setting > General.

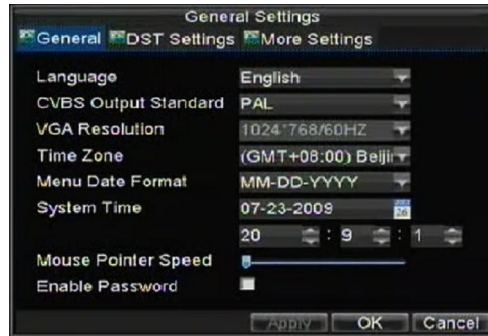

2. Select the **General** tab.

3. Configure general settings. These settings include:

**Language:** Default language used in DVR menus.

**CVBS Output Standard:** Video output standard: NTSC and PAL.

**VGA Resolution:** VGA output resolution.

**Time Zone:** Time zone to use for DVR.

**Menu Date Format:** Format to use for date.

**System Time:** System time and date.

**Mouse Pointer Speed:** Speed of mouse pointer.

**Enable Password:** Enable/disable system password.

**Note:** If the video standard is different between the input and the output, you may notice flickering in Live Preview mode.

### 12.2 Configuring Advanced Settings

To configure more advanced settings:

1. Enter the General Settings menu, shown above by clicking Menu > Setting > General.

2. Click the **More Settings** tab; this will take you to the More Settings menu, shown below.

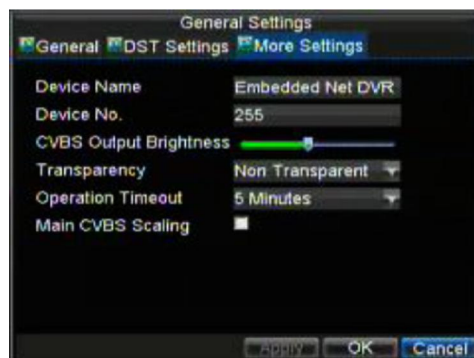

3. Configure settings, including:

**Device Name:** Name to use for DVR.

**Device No.:** Device number to use for DVR.

**CVBS Output Brightness:** Video output brightness.

**Transparency:** Menu transparency.

**Operation Timeout:** Set timeout time for menu inactivity. For example, if timeout time was set to 5 minutes, after 5 minutes of inactivity in the General Settings menu, you will be returned to the Live Preview.

• **Enable Output Hint:** To display output status in preview.

• **CVBS Scaling:** Enable/disable video output scaling for main/aux video output.

### 12.3 Configuring RS-232 Port Settings

**Special Note:** Whilst an RS232 connection is available on this unit support for this service is not available.

To configure RS-232 devices to be used with the DVR:

1. Enter the RS-232 Settings menu, shown in by clicking Menu > Setting > RS232.



2. Configure RS-232 Settings.

3. The RS-232 port can be used in two ways:

**Parameter Control:** Connect a PC to the DVR using the PC serial port. Device parameters can then be set using software such as HyperTerminal. The serial port parameters must be the same as the DVRs when connecting with the PC serial port.

**Transparent Channel:** Connect a serial device directly to the DVR. The serial device will be controlled remotely by the PC through the network and the protocol of the serial device.

**Note:** Please note that the remote control features through the RS-232 port are limited.

## 12.4 Managing User Accounts

By default, your DVR comes with one user account, the **Administrator** account. The **Administrator** user name is **admin** and the password is **12345**. The default password for **Administrator** should be changed right away (see SPECIAL NOTE below) for security reasons. **The Administrator** has the authority to add, delete or configure parameters for many of the system functions.

**SPECIAL NOTE: This DVR only has one default Administrator user account and if the password is changed and lost or a mistake is made in inputting the new password, the menu may not be accessible and the unit will have to be returned to the supplier. It is therefore recommended that before you change the password, you set up a new user account and password and allocate full privileges to this user, then test you have access to the menu before changing the default password.**

### 12.4.1 Adding a New User

You may add up to 31 new users to your DVR. To add new users:

Enter the User Settings menu, shown below by clicking Menu > Setting > User.

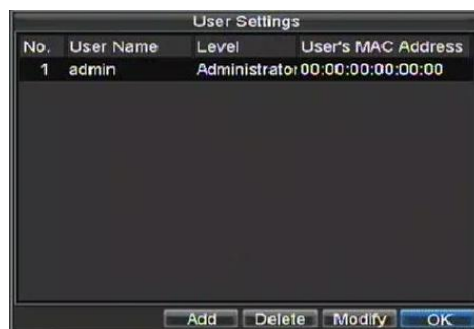

1. Select the Add button to enter the Add User menu, shown below.





2. Enter information for new user, including **User Name**, **Password**, **Level** and **User's MAC**.

3. The **Level** is the user level and is separated into two tiers.

**Operator:** The Operator user level has the authority to configure two-way audio in network settings and all parameters in channel settings.

**Guest:** The Guest user cannot configure network settings, but can configure the local playback as well as the remote playing in channel settings.

4. If **User's MAC** is configured and enabled, the user may only access the DVR from that particular MAC address.

5. Select the **Permission** button to enter the **Privilege Settings** menu, shown below.

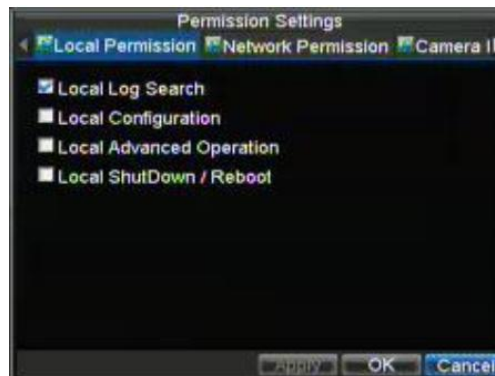

6. Configure privileges for local settings under **Local Permission** tab. The local settings include:

**Local Log Search:** Search and view logs of DVR.

**Local Configuration:** Configure and restore parameters to factory defaults. Introduce settings to or export settings from DVR.

**Local Advanced Management:** HDD management (including the initialisation and changing the properties of a disk). Ability to update system firmware as well as to stop the relay output

**Local Shutdown/Reboot:** Shutdown or reboot the DVR.

7. Click on the **Network Permission** tab to configure network privileges, as shown below.



The network settings include:

**Remote Log Search:** Remotely view logs that are saved on the DVR.

**Remote Configuration:** Remotely configure parameters, restore parameters to factory defaults and import settings to as well as export settings from DVR.

**Remote Serial Port Control:** Configure settings for RS232 and RS485 ports.

**Remote Video Output Control:** Configure settings for video output.

**Two-Way Audio:** Ability to use two-way audio between the remote client and the DVR.

**Remote Alarm Control:** Remote alert or control the relay output of the DVR. Alarm and exception settings must be configured properly to upload to host.

**Remote Advanced Management:** Remotely manage hard disk drives (initialising and setting properties for HDDs). Ability to remote update system firmware and stop of the relay output

**Remote Shutdown/Reboot:** Remotely shutdown or reboot the DVR.

8. Click on the **Channel Permission** tab to configure channel privileges, as shown below.



The channel settings include:

**Remote Live View:** Select and view live video over the network.

**Local Manual Record:** Locally start and stop manual recording on any of the channels.

**Remote Record Starting:** Remotely start and stop manual recording on any of the channels.

**Local Playback:** Locally play recorded files that are on the DVR.

**Remote Playback:** Remotely play and download recorded files that are on the DVR.

**Local PTZ Control:** Locally control PTZ cameras.

**Remote PTZ Control:** Remotely control PTZ cameras.

**Local Video Export:** Locally backup recorded files from any of the channels.

9. Click the OK button to save and exit menu.

#### 12.4.2 Deleting a User

To delete a user from the DVR:

1. Enter the User Settings menu by clicking Menu > Settings > User.

2. Select user to delete.

3. Click the Delete button to delete user.

4. Click the OK button to exit menu.

### 12.4.3 Modifying a User

To modify a user:

1. Enter the User Settings menu by clicking Menu > Settings > User.
2. Select user to modify.
3. Click the Modify button to enter the Modify menu, shown below.

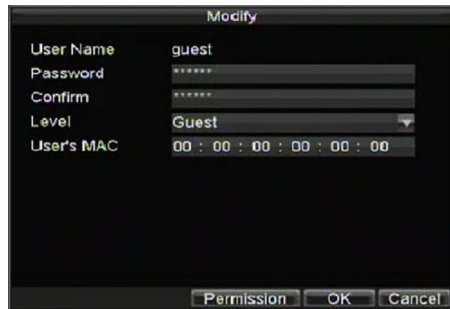

4. Edit user information.
5. To modify user permissions, click on the privileges button. Permissions settings are defined in the section above, **Adding a New User**.
6. Click the OK button to exit menu.

### 12.5 Importing & Exporting Configuration

Configuration information from your DVR can be exported to a USB device and imported into another DVR. This will allow you to efficiently setup the same configuration on numerous DVRs.

To import or export DVR configuration:

1. Enter the Import/Export Configuration menu, shown below by clicking Menu > Maintenance > Configuration.



2. Click Export to export a configuration file to USB device. USB device must be connected at this point to the DVR.
3. To import a configuration file, select the file from the USB device and click the Import button. After the import process is completed, you must reboot the DVR.
4. Click Cancel to exit out of menu.

## 12.6 Updating System Firmware

The firmware on your DVR can be updated using two methods. These methods include updating via an USB device or over the network via an FTP server.

### To update via a USB device:

1. Connect USB device to DVR. The firmware file must be located in the root directory of your USB device.
2. Enter the Firmware Update menu, shown below by clicking Menu > Maintenance > Upgrade.



3. Select the **Local Upgrade** tab.
4. Select the firmware on the USB device.
5. Select Upgrade to begin the update process.
6. After the system firmware has been updated, reboot the DVR.

### To update via an FTP server:

1. Configure PC (running FTP server) and DVR to be in the same Local Area Network. Run the 3rd-party TFTP software on the PC and copy the firmware into the root directory of TFTP.
2. Enter the Firmware Update menu by clicking Menu > Maintenance > Upgrade.
3. Select the **FTP** tab, shown below.



4. Input the FTP server address.
5. Select Upgrade to begin update process.
6. After the system firmware has been update, reboot the DVR.

**Note:** If the DVR fails to update, please contact your system supplier for further assistance.

## 12.7 Restoring Default Settings

To restore default factory settings to your DVR:

1. Enter the Default Settings menu, shown below by clicking Menu > Maintenance > Default.

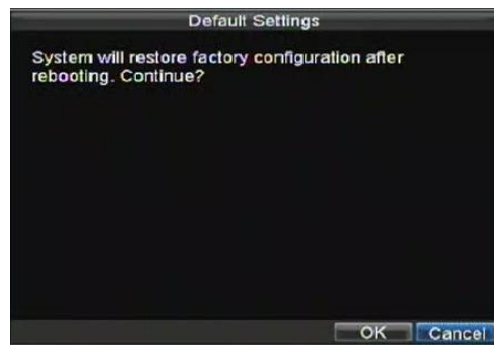

Select OK to restore factory defaults.

**Note:** Network information such as IP address, subnet mask and gateway will not be restored. **If alarm sounds following restore then additional changes are required.**  
**See section 16.2.**

## 12.8 Viewing System Information

To view system information:

1. Enter into the Information menu, shown below by clicking Menu > Maintenance > Information.

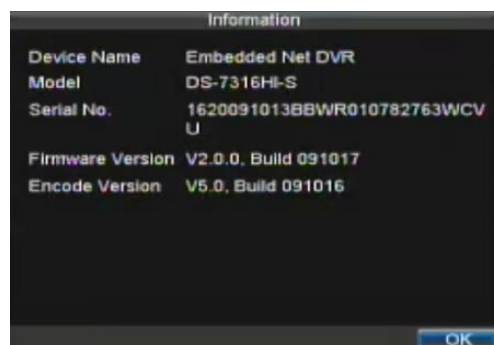

2. Select OK to exit to the previous screen.

## 12.9 Viewing System Logs

Many events of your DVR are logged into the system logs.

To access the system logs and search for these events:

1. Enter the Log Search menu, shown below by clicking Menu > Maintenance > Log Search.



2. Set search parameters.

3. Click the Search button to begin search. If logs matching the search criteria are found, it will be displayed in a list similar to that below.



4. To view more detail information about a particular log entry, select the entry and click the Details button.

5. If applicable, you may also view the associated video to the selected log entry by clicking the Play button.

6. Log files can also be exported onto a USB device. To export a log file, connect a USB device to the DVR, select the log file to export and click the Export button. This will take you to the Log Search Export menu, shown below. Click the Export button to export log onto USB device. The exported file will be named according to the time it was exported (i.e. 2000062991627.txt).



7. Click Cancel to exit out of menu.

## 13. Glossary

**Dual Stream:** Dual stream is a technology used to record high resolution video locally while transmitting a lower resolution stream over the network. The two streams are generated by the DVR, with the main stream having a maximum resolution of 4CIF and the sub-stream having a maximum resolution of QCIF.

**DVR:** Acronym for Digital Video Recorder. A DVR is device that is able to accept video signals from analogue cameras, compress the signal and store it on its hard drives.

**HDD:** Acronym for Hard Disk Drive. A storage medium which stores digitally encoded data on platters with magnetic surfaces.

**DHCP:** Dynamic Host Configuration Protocol (DHCP) is a network application protocol used by devices (DHCP clients) to obtain configuration information for operation in an Internet Protocol network.

**HTTP:** Acronym for Hypertext Transfer Protocol. A protocol to transfer hypertext request and information between servers and browsers over a network

**PPPoE:** PPPoE, Point-to-Point Protocol over Ethernet, is a network protocol for encapsulating Point-to-Point Protocol (PPP) frames inside Ethernet frames. It is used mainly with ADSL services where individual users connect to the ADSL transceiver (modem) over Ethernet and in plain Metro Ethernet networks. Not used in UK.

**DDNS:** Dynamic DNS is a method, protocol, or network service that provides the capability for a networked device, such as a router or computer system using the Internet Protocol Suite, to notify a domain name server to change, in real time (ad-hoc) the active DNS configuration of its configured hostnames, addresses or other information stored in DNS.

**NTP:** Acronym for Network Time Protocol. A protocol designed to synchronise the clocks of computers over a network.

**NTSC:** Acronym for National Television System Committee. NTSC is an analogue television standard used in such countries as the United States and Japan. Each frame of an NTSC signal contains 525 scan lines at 60Hz.

**PAL:** Acronym for Phase Alternating Line. PAL is also another video standard used in broadcast televisions systems in large parts of the world. PAL signal contains 625 scan lines at 50Hz. Used in the UK.

**PTZ:** Acronym for Pan, Tilt, Zoom. PTZ cameras are motor driven systems that allow the camera to pan left and right, tilt up and down and zoom in and out.

**USB:** Acronym for Universal Serial Bus. USB is a plug-and-play serial bus standard to interface devices to a host computer.



## 14. Frequently Asked Questions

### **Why does my DVR make a beeping sound after booting?**

There are a few reasons for the warning beep your DVR makes after booting.

1. There is no HDD present in the DVR.
2. The HDD has not been initialised.
3. The HDD is defective.
4. The DVR Restore Defaults have been set. Refer to section 16.2.

If you wish to use your DVR without any HDDs, you may disable this warning beep in the Exception Settings menu (See **Setting Exception**).

### **Why does the DVR seem unresponsive when operating with the IR remote control?**

If your DVR seems unresponsive when using the IR remote and you have read through the section **Using the IR Remote Control**, please check:

1. Check that the batteries are installed correctly in the remote, making sure that the polarities of the batteries are not reversed.
2. Make sure the batteries are fresh and are not out of power.
3. Make sure the remote has not been tampered with.
4. Check around and make sure there are no fluorescent lamps in use.

### **Why does the PTZ seem unresponsive?**

If the PTZ seems unresponsive::

1. Check that the RS-485 cable is properly connected.
2. Check that the dome protocol type is correctly set in menu.
3. Check that the dome baud rate is correctly set in menu.
4. Check that the dome address is correctly set in the menu.
5. Check to make sure that the main board RS485 interface is not faulty.
6. Check the RS485 data cable from the PTZ is connected to the T+ and T- connections on the DVR. Also ensure that orange connects to T+ and yellow connects to T-.

### **Why is there no video recorded after setting the motion detection?**

If there is no recorded video after setting the motion detection, please check:

1. Check that the recording schedule is setup correctly by following the steps listed in **Scheduling a Recording**.
2. Check that the motion detection area is configured correctly (See **Setting Up Motion Detection**).
3. Make sure that channels are being triggered for motion detection (See **Setting Up Motion Detection**).

### **Why doesn't the DVR detect my USB export device for exporting recorded files?**

There is a chance that the DVR and your USB device are not compatible. Please try another device.

## 15. Record Timings

### 15.1 Record Timings for Alien416

#### CIF mode

Frame Rate	HDD 320Gb	HDD 640Gb	HDD 750Gb	HDD 1.0Tb	HDD 1.5Tb	HDD 2.0Tb
25	3dys 7hr	6dy 14hr	7dy 17hr	10dy 7hr	15dy 11hr	20dy 14hr
12	6dys 14hr	13dy 4hr	15dy 11hr	20dy 14hr	30dy 22hr	41dy 5hr
6	13dy 4hr	26dy 9hr	30dy 22hr	41dy 5hr	61dy 20hr	82dy 10hr
4	17dy 14hr	35dy 4hr	41dy 5hr	54dy 23hr	82dy 10hr	109dy 22hr
2	35dy 4hr	70dy 8hr	82dy 10hr	109dy 22hr	164dy 21hr	219dy 20hr
1	52dy 18hr	105dy 12hr	123dy 16hr	164dy 21hr	247dy 8hr	329dy 18hr

#### 2CIF mode

Frame Rate	HDD 320Gb	HDD 640Gb	HDD 750Gb	HDD 1.0Tb	HDD 1.5Tb	HDD 2.0Tb
25	1dy 15hr	3dy 7hr	3dy 20hr	5dy 3hr	7dy 17hr	10dy 7hr
12	3dy 7hr	6dy 14hr	7dy 17hr	10dy 7hr	15dy 11hr	20dy 14hr
6	6dy 14hr	13dy 4hr	15dy 11hr	20dy 14hr	30dy 22hr	41dy 5hr
4	8dy 19hr	7dy 14hr	20dy 14hr	27dy 11hr	41dy 5hr	54dy 23hr
2	17dy 14hr	35dy 4hr	41dy 5hr	54dy 23hr	82dy 10hr	109dy 22hr
1	26dy 9hr	52dy 18hr	61dy 20hr	82dy 10hr	123dy 16hr	164dy 21hr

#### 4CIF mode (Maximum 12FPS)

Frame Rate	HDD 320Gb	HDD 640Gb	HDD 750Gb	HDD 1.0Tb	HDD 1.5Tb	HDD 2.0Tb
12	1dy 15hr	3dy 7hr	3dy 20hr	5dy 3hr	7dy 17hr	10dy 7hr
6	3dy 7hr	6dy 14hr	7dy 17hr	10dy 7hr	15dy 11hr	20dy 14hr
4	4dy 9hr	3dy 19hr	10dy 7hr	13dy 17hr	20dy 14hr	27dy 11hr
2	8dy 19hr	17dy 14hr	20dy 14hr	27dy 11hr	41dy 5hr	54dy 23hr
1	17dy 14hr	35dy 4hr	41dy 5hr	54dy 23hr	82dy 10hr	109dy 22hr

## 15.2 Record Timings for Alien408

### CIF mode

Frame Rate	HDD 320Gb	HDD 640Gb	HDD 750Gb	HDD 1.0Tb	HDD 1.5Tb	HDD 2.0Tb
25	6dy 14hr	13dy 4hr	15dy 11hr	20dy 14hr	30dy 22hr	41dy 5hr
12	13dy 4hr	26dy 9hr	30dy 22hr	41dy 5hr	61dy 20hr	82dy 10hr
6	26dy 9hr	52dy 18hr	61dy 20hr	82hr 10hr	123dy 16hr	164dy 21hr
4	35dy 4hr	70dy 8hr	82dy 10hr	109dy 22hr	164dy 21hr	219dy 20hr
2	70dy 8hr	140dy 17hr	164dy 21hr	219dy 20hr	329dy 18hr	439dy 17hr
1	105dy 12hr	211dy 1hr	247dy 8hr	329dy 18hr	494dy 16hr	659dy 13hr

### 2CIF mode

Frame Rate	HDD 320Gb	HDD 640Gb	HDD 750Gb	HDD 1.0Tb	HDD 1.5Tb	HDD 2.0Tb
25	3dys 7hr	6dy 14hr	7dy 17hr	10dy 7hr	15dy 11hr	20dy 14hr
12	6dys 14hr	13dy 4hr	15dy 11hr	20dy 14hr	30dy 22hr	41dy 5hr
6	13dy 4hr	26dy 9hr	30dy 22hr	41dy 5hr	61dy 20hr	82dy 10hr
4	17dy 14hr	35dy 4hr	41dy 5hr	54dy 23hr	82dy 10hr	109dy 22hr
2	35dy 4hr	70dy 8hr	82dy 10hr	109dy 22hr	164dy 21hr	219dy 20hr
1	52dy 18hr	105dy 12hr	123dy 16hr	164dy 21hr	247dy 8hr	329dy 18hr

### 4CIF mode (Maximum 12FPS)

Frame Rate	HDD 320Gb	HDD 640Gb	HDD 750Gb	HDD 1.0Tb	HDD 1.5Tb	HDD 2.0Tb
12	3dys 7hr	6dy 14hr	7dy 17hr	10dy 7hr	15dy 11hr	20dy 14hr
6	6dys 14hr	13dy 4hr	15dy 11hr	20dy 14hr	30dy 22hr	41dy 5hr
4	13dy 4hr	26dy 9hr	30dy 22hr	41dy 5hr	61dy 20hr	82dy 10hr
2	17dy 14hr	35dy 4hr	41dy 5hr	54dy 23hr	82dy 10hr	109dy 22hr
1	35dy 4hr	70dy 8hr	82dy 10hr	109dy 22hr	164dy 21hr	219dy 20hr

### 15.3 Record Timings for Alien404

#### CIF mode

Frame Rate	HDD 320Gb	HDD 640Gb	HDD 750Gb	HDD 1.0Tb	HDD 1.5Tb	HDD 2.0Tb
25	13dy 4hr	26dy 9hr	30dy 22hr	41dy 5hr	61dy 20hr	82dy 10hr
12	26dy 9hr	52dy 18hr	61dy 20hr	82dy 10hr	123dy 16hr	164dy 21hr
6	52dy 18hr	105dy 12hr	123dy 16hr	164dy 21hr	247dy 8hr	329dy 18hr
4	70dy 8hr	140dy 17hr	164dy 21hr	219dy 20hr	329dy 18hr	439dy 17hr
2	140dy 17hr	281dy 10hr	329dy 18hr	439dy 17hr	659dy 13hr	879dy 10hr
1	211dy 1hr	422dy 3hr	494dy 16hr	659dy 13hr	989dy 8hr	1319dy 3hr

#### 2CIF mode

Frame Rate	HDD 320Gb	HDD 640Gb	HDD 750Gb	HDD 1.0Tb	HDD 1.5Tb	HDD 2.0Tb
25	6dy 14hr	13dy 4hr	15dy 11hr	20dy 14hr	30dy 22hr	41dy 5hr
12	13dy 4hr	26dy 9hr	30dy 22hr	41dy 5hr	61dy 20hr	82dy 10hr
6	26dy 9hr	52dy 18hr	61dy 20hr	82dy 10hr	123dy 16hr	164dy 21hr
4	35dy 4hr	70dy 8hr	82dy 10hr	109dy 22hr	164dy 21hr	219dy 20hr
2	70dy 8hr	140dy 17hr	164dy 21hr	219dy 20hr	329dy 18hr	439dy 17hr
1	140dy 17hr	281dy 10hr	329dy 18hr	439dy 17hr	659dy 13hr	879dy 10hr

#### 4CIF mode (Maximum 12FPS)

Frame Rate	HDD 320Gb	HDD 640Gb	HDD 750Gb	HDD 1.0Tb	HDD 1.5Tb	HDD 2.0Tb
12	6dy 14hr	13dy 4hr	15dy 11hr	20dy 14hr	30dy 22hr	41dy 5hr
6	13dy 4hr	26dy 9hr	30dy 22hr	41dy 5hr	61dy 20hr	82dy 10hr
4	17dy 14hr	35dy 4hr	41dy 5hr	54dy 23hr	82dy 10hr	109dy 22hr
2	35dy 4hr	70dy 8hr	82dy 10hr	109dy 22hr	164dy 21hr	219dy 20hr
1	70dy 8hr	140dy 17hr	164dy 21hr	219dy 20hr	329dy 18hr	439dy 17hr

## 16. Special Features

### 16.1 1fps background recording switching to 25fps in CIF

This DVR has a special feature that allows the unit to be set for recording at a low frame rate but when motion is detected to revert to 25fps recording.

1. Enter System Settings.

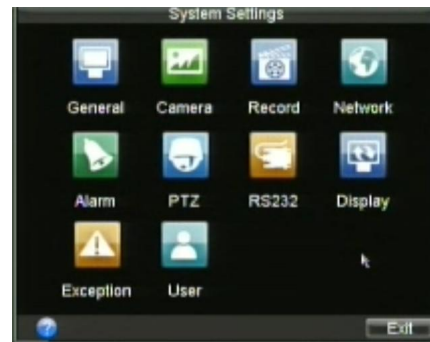

2. Select camera number required  
3. Ensure Encoding Parameters set to Normal.

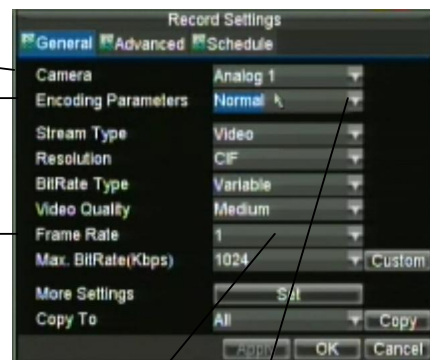

4. Reduce frame rate to low rate.

5. Select OK and re-enter Record Settings.

6. Click the Encoding Parameter again for same channel but click on down arrow and select Event.

7. Select higher Frame Rate (example 25 fps)

8. Select OK

9. Select Camera Settings.

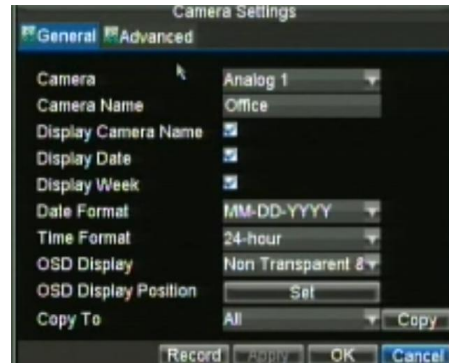

10. Select Advanced tab

11. Tick Motion Detection Box

12. Click on Area Settings

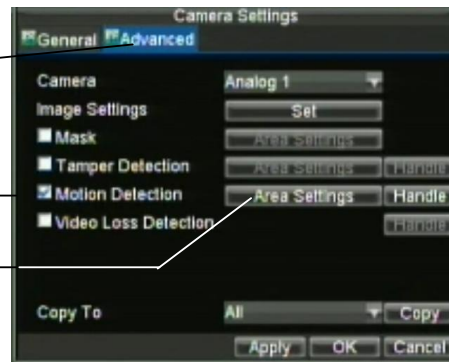

13. Drag detection box to cover detection area.



14. If you enter the Handle option you can tick the Pop-up image on Monitor to display a single screen display of the triggered camera.

15. Click on OK and confirm in each menu to save.

16. Repeat for other camera channels.

17. To check that settings are correct, the red record light must be on permanently and when motion occurs the yellow icon for event will display.

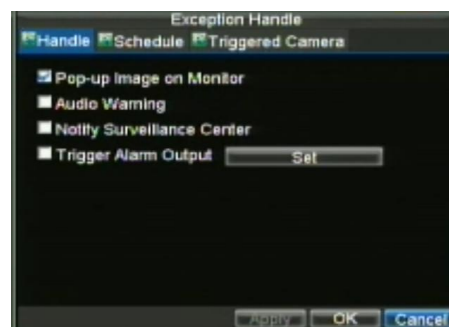

## 16.2 Special Instructions following Restoring Default Settings

If you get an alarm following a restore of the Default Settings you will need to take the following action:

1. Right click mouse button and click on **Menu**.
2. Enter password, click on **Enter** and then **OK**.
3. Click on **Setting** menu.
4. Click on **Exception** menu.
5. Click on **Exception Type** drop down arrow and select **ALL** followed by **OK**.  
**This will now cancel the alarm.**
  
6. Click on **General** menu.
7. Change **CVBS Output Standard** from **NTSC** to **PAL**.
8. Select **Time Zone** and change to **(GMT + 00.00) Dublin, Edinburgh, London**.
9. Change Menu Date Format to **DD-MM-YYYY**.
10. Check system Date & Hour. The Date may be okay. Click on **APPLY** and **OK**.
11. Click on **Exit** twice to leave menu.